

Molded Case Circuit Breakers

1
2
3
4
5
6
7
8
9
10
11
12
13
14
15
16
17

240V Circuit Breakers



BQ Breakers

Selection and ordering data

	240V
BQ	10KAIC
BQH	22KAIC
HBQ	65KAIC

1-, 2- & 3-pole up to 125A for circuit protection up to 240 volt circuits (UL)

Information	Page
General Data	17/9–17/10
Accessories	17/105–17/112



QJ Breakers

Selection and ordering data

	240V
QJ2	10KAIC
QJH-2	22KAIC
QJ2-H	42KAIC
HQJ2	65KAIC

2- & 3-pole up to 225A for circuit protection up to 240 volt circuits (UL)

Information	Page
General Data	17/11
Accessories	17/105–17/112

600/347V Circuit Breakers



CQD Breakers

Selection and ordering data

	480/277V	600/347V
CQD	14KAIC	—
CQD-6	—	10KAIC

1-, 2- & 3-pole up to 100A for circuit protection up to 600/347V (CSA) & 480/277V (UL) circuits

Information	Page
General Data	17/12
Internal Accessories	17/14
External Accessories	17/105–17/112

600/347V Circuit Breakers



GG Breakers

Selection and ordering data

	480V	600/347V
NGG	25KAIC	14KAIC
HGG	35KAIC	14KAIC
LGG	65KAIC	14KAIC

1-, 2- & 3-pole up to 125A for circuit protection up to 600/347 volt circuits (UL/CSA/IEC)

Information	Page
General Data	17/13
Internal Accessories	17/14
External Accessories	17/105–17/112

600V Circuit Breakers



DG VL Breakers

Selection and ordering data

	480V	600Y/347V
NDG	35KAIC	18KAIC
HDG	65KAIC	18KAIC
LDG	100KAIC	18KAIC

2- & 3-pole up to 150A for circuit protection up to 600 volt circuits (UL/CSA/IEC)

Information	Page
Breakers & Trip Units	17/17–17/19
Internal Accessories	17/23
External Accessories	17/43–17/57



FG VL Breakers

Selection and ordering data

	480V	600V
NFG	35KAIC	18KAIC
HFG	65KAIC	20KAIC
LFG	100KAIC	25KAIC

2- & 3-pole up to 150A for circuit protection up to 600 volt circuits (UL/CSA/IEC)

Information	Page
General Data	17/20–17/22
Internal Accessories	17/23
External Accessories	17/43–17/57

Molded Case Circuit Breakers

600V Circuit Breakers



JG VL Breakers

Selection and ordering data

	480V	600V
NJG	35KAIC	25KAIC
HJG	65KAIC	25KAIC
LJG	100KAIC	25KAIC

2- & 3-pole up to 400A for circuit protection up to 600 volt circuits (UL/CSA/IEC)

Information	Page
General Data	17/24-17/26
Internal Accessories	17/30
External Accessories	17/43-17/57



LG VL Breakers

Selection and ordering data

	480V	600V
NLG	35KAIC	18KAIC
HLG	65KAIC	18KAIC
LLG	100KAIC	18KAIC

2- & 3-pole up to 600A for circuit protection up to 600 volt circuits (UL/CSA/IEC)

Information	Page
General Data	17/27-17/29
Internal Accessories	17/30
External Accessories	17/43-17/57



MG VL Breakers

Selection and ordering data

	480V	600V
NMG	35KAIC	25KAIC
HMG	65KAIC	35KAIC
LMG	100KAIC	50KAIC

2- & 3-pole up to 800A for circuit protection up to 600 volt circuits (UL/CSA/IEC)

Information	Page
General Data	17/31-17/33
Internal Accessories	17/39
External Accessories	17/43-17/57

600V Circuit Breakers



NG VL Breakers

Selection and ordering data

	480V	600V
NNG	35KAIC	25KAIC
HNG	65KAIC	35KAIC
LNG	100KAIC	65KAIC

2- & 3-pole up to 1200A for circuit protection up to 600 volt circuits (UL/CSA/IEC)

Information	Page
General Data	17/34-17/36
Internal Accessories	17/39
External Accessories	17/43-17/57



PG VL Breakers

Selection and ordering data

	480V	600V
NPG	35KAIC	25KAIC
HPG	65KAIC	35KAIC
LPG	100KAIC	65KAIC

2- & 3-pole up to 1600A for circuit protection up to 600 volt circuits (UL/CSA/IEC)

Information	Page
General Data	17/37-17/38
Internal Accessories	17/39
External Accessories	17/43-17/57

VL Circuit Breakers: Additional Information

Contents	Page
Table of Contents	17/1-17/4
Catalog Numbering System	17/5-17/8
Trip Unit Overview	17/15-17/16
Molded Case Switch	17/40
Molded Case Protector	17/41
600 Volt DC Circuit Breakers	17/42
Accessory Locations	17/58
Suffix for Internal Accessories	17/59
Technical Data	17/60-17/61
Unusual Operating Conditions	17/62
Breaker Modifications	17/104
400 Hz Systems	17/115

600V Circuit Breakers

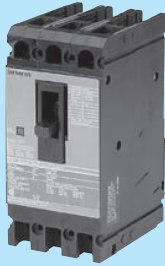

Sentron ED Breakers

Selection and ordering data

	240V	480V	600V
ED2	10KAIC	—	—
ED4	65KAIC	18KAIC	—
ED6	65KAIC	25KAIC	18KAIC

1-, 2- & 3-pole up to 125A for circuit protection up to 600 volt circuits (UL/CSA/IEC)

Information	Page
General Data	17/63
Internal Accessories	17/65
External Accessories	17/105-17/112

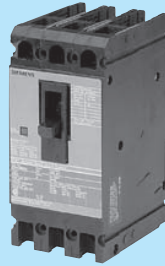

Sentron HED/CED Breakers

Selection and ordering data

	480V	600V
HED4	42KAIC	—
CED6	200KAIC	100KAIC

1-, 2- & 3-pole up to 125A for circuit protection up to 600 volt circuits (UL/CSA/IEC)

Information	Page
General Data	17/64
Internal Accessories	17/65
External Accessories	17/105-17/112



Sentron FD Breakers

Selection and ordering data

	480V	600V
FD6	35KAIC	22KAIC
HFD6	65KAIC	25KAIC
HHFD6	100KAIC	25KAIC
CFD6	200KAIC	100KAIC

2- & 3-pole up to 250A for circuit protection up to 600 volt circuits (UL/CSA/IEC)

Information	Page
General Data	17/66-67
Internal Accessories	17/68
External Accessories	17/105-17/112

600V Circuit Breakers



Sentron JD Breakers

Selection and ordering data

	240V	480V	600V
JD2	65KAIC	—	—
JD6, SJD6-A	65KAIC	35KAIC	25KAIC
HHJD6	200KAIC	100KAIC	50KAIC
CJD6, SCJD6-A	200KAIC	150KAIC	100KAIC
HJD6, SHJD6-A	100KAIC	65KAIC	35KAIC

2- & 3-pole up to 400A for circuit protection up to 600 volt circuits (UL/CSA)

Information	Page
General Data	17/69-17/71
Internal Accessories	17/72
External Accessories	17/105-17/112



Sentron LD Breakers

Selection and ordering data

	480V	600V
LD6, SLD6-A	35KAIC	25KAIC
HLD6, SHLD6-A	65KAIC	25KAIC
HHLD6	100KAIC	50KAIC
CLD6, SCLD6-A	150KAIC	100KAIC

2- & 3-pole up to 600A for circuit protection up to 600 volt circuits (UL/CSA)

Information	Page
General Data	17/73-17/75
Internal Accessories	17/76
External Accessories	17/105-17/112



Sentron LMD Breakers

Selection and ordering data

	480V	600V
LMD6	50KAIC	25KAIC
HLMD6	65KAIC	50KAIC

2- & 3-pole up to 800A for circuit protection up to 600 volt circuits (UL/CSA)

Information	Page
General Data	17/77-17/78
Internal Accessories	17/79
External Accessories	17/105-17/112

Molded Case Circuit Breakers

600V Circuit Breakers



Sentron MD Breakers

Selection and ordering data

	480V	600V
MD, SMD6	50KAIC	25KAIC
HMD, SHMD6	65KAIC	50KAIC
CMD, SCMD6	100KAIC	65KAIC

2- & 3-pole up to 800A for circuit protection up to 600 volt circuits (UL/CSA)

Information	Page
General Data	17/80-17/82
Internal Accessories	17/86
External Accessories	17/105-17/112



Sentron ND Breakers

Selection and ordering data

	480V	600V
ND, SND6	50KAIC	25KAIC
HND, SHND6	65KAIC	50KAIC
CND, SCND6	100KAIC	65KAIC

2- & 3-pole up to 1600A for circuit protection up to 600 volt circuits (UL/CSA)

Information	Page
General Data	17/83-17/85
Internal Accessories	17/86
External Accessories	17/105-17/112



Sentron PD Breakers

Selection and ordering data

	480V	600V
PD, SPD6	50KAIC	25KAIC
HPD, SHPD6	65KAIC	50KAIC
CPD	100KAIC	65KAIC

2- & 3-pole up to 1600A for circuit protection up to 600 volt circuits (UL/CSA)

Information	Page
General Data	17/87-17/88
Internal Accessories	17/90
External Accessories	17/105-17/112

600V Circuit Breakers



Sentron RD Breakers

Selection and ordering data

	480V	600V
RD	50KAIC	25KAIC
HRD	65KAIC	50KAIC

2- & 3-pole up to 2000A for circuit protection up to 600 volt circuits (UL/CSA)

Information	Page
General Data	17/89
Internal Accessories	17/90
External Accessories	17/105-17/112

Sentron Circuit Breakers: Additional Information

Contents	Page
Table of Contents	17/1-17/4
Catalog Numbering System	17/5-17/8
ETI Motor Circuit Protector	17/91-17/93
Adjustable Magnetic Trip Setting	17/94-17/96
Molded Case Switch	17/97
Internal Accessories-Combinations	
Sensitrip III Electronic Trip Breakers	17/98-17/99
Electronic & Communication Accessories	17/100
Lug Information	17/101-17/103
Unusual Operating Conditions	17/114
Breaker Modifications	17/115
400 Hz Systems	17/116

Ordering

In the FD through RD frames, you may order molded case circuit breakers three basic ways:

- As separately ordered frames, trip units and lugs
- As frame, trip unit and lugs ordered as one catalog number and shipped unassembled or assembled
- As Frame and Trip Unit shipped assembled and with the trip unit made non-removable, in compliance with UL 489 requirements that to be reverse fed the circuit breaker must not have an interchangeable trip unit.

These two options are described in the following:

Components Ordered Separately

To get the components for a 3-pole, 400 Amp standard interrupting circuit breaker, you would order the frame (JD63F400), the trip unit (JD63T400) and six lugs (TA2J6500). This option is normally useful only if you stock and use large volumes of product and wish to reduce your inventory cost. You may stock, for example, a smaller number of frames (JD63F400) and a variety of trip units (JD63T300, JD63T350, etc.) and assemble breakers as you need them.

Frame, Trip Unit and Lugs Ordered Together

If you order the catalog number JD63B400, you will receive a frame, a trip unit and 6 lugs in separate packages. By suffixing this number with "L" (e.g. JD63B400L), you will receive frame, trip unit and lugs assembled in one container. Pursuant to UL 489, a product ordered thus will have the markings "LINE" and "LOAD", and may not be "reverse fed" (with power flowing from the "OFF" end of the breaker toward the "ON" end).

Non-Interchangeable Trip Breakers

If you place an "X" after the frame size designator (e.g. JXD63B400), you will receive a frame and trip unit assembled, with the trip unit made non-removable. If you suffix an "L" to this catalog number (e.g. JXD63B400L), you will receive the breaker, non-removable trip unit and lugs assembled. Unless you anticipate a specific need to change the breaker's ampere rating in the future, this is the preferred ordering method, as the products are assembled to Siemens' specifications in our factories. These breakers are suitable for use reverse fed according to UL 489, since the trip unit is not removable.

The smaller frames (QJ, ED and below) do not have removable trip units, and consequently are shipped only as assembled products. To add lugs, see the ordering instructions on each product's catalog page.

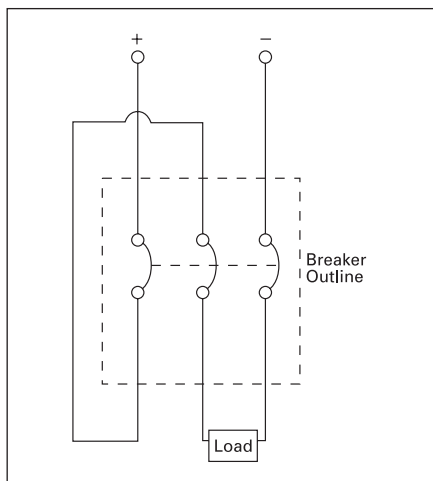

500V DC Wiring Configuration

Connecting Breakers for DC Application

Most Siemens thermal magnetic trip MCCBs are applicable on direct current (dc) systems. Generally, for 250 V dc systems a two pole breaker is used, with one pole on each leg of the supply circuit. For three pole breakers applied on 500 V undergrounded DC systems, it is important to connect the power supply "zig-zag" through the breaker as shown in the figure below. This assures that the Voltage between phases on the breaker terminals is uniformly distributed.

VL Molded Case Circuit Breakers

Catalog Numbering System

Selection/Application

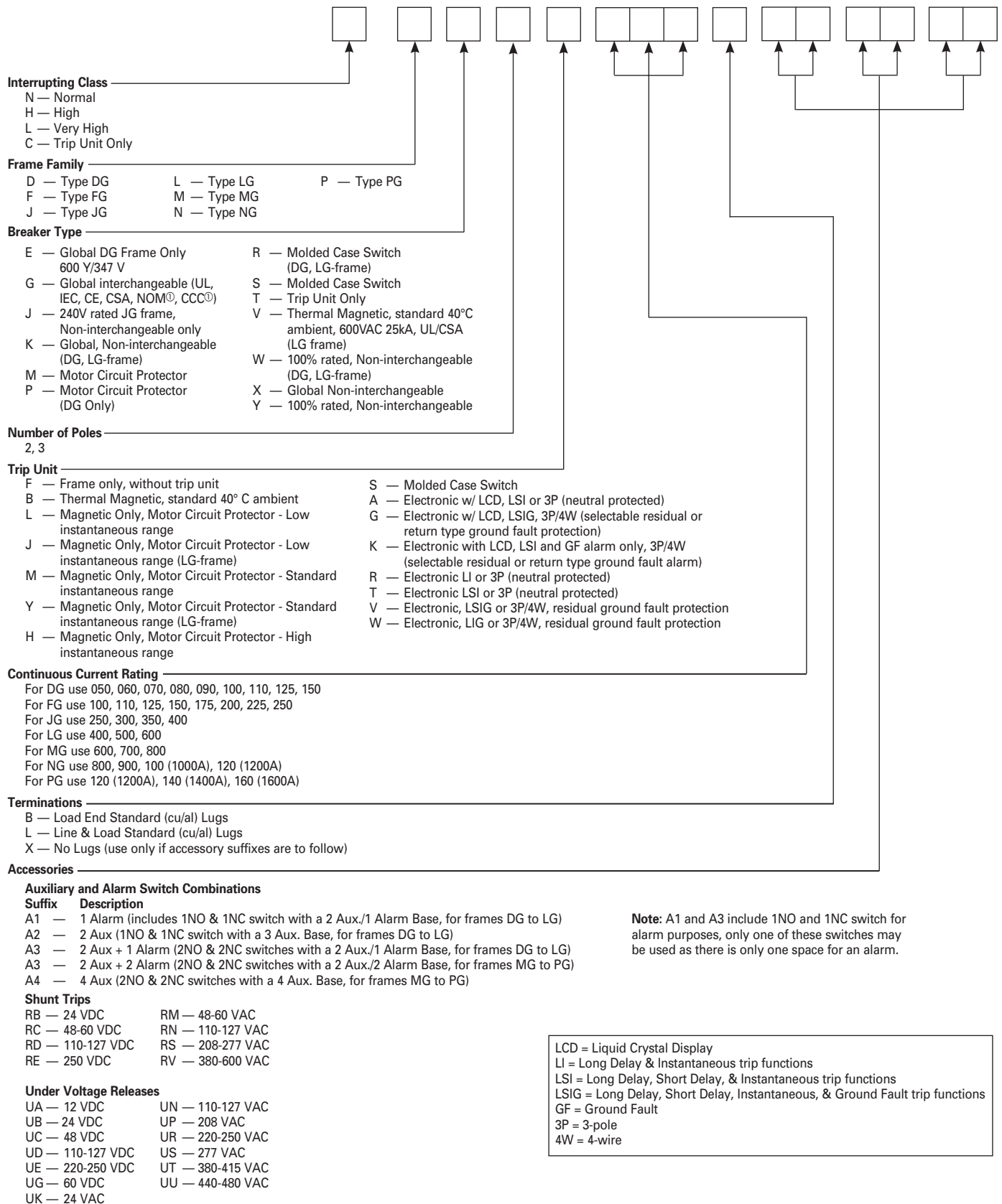

If ordering factory-installed accessories or special modifications, you must order a 15-digit catalog number. See the examples below for a detailed explanation. The 15 digit number is achieved by placing X's in positions not being occupied by an accessory/modification. Contact Siemens for circuit breakers configured with accessories.

Auxiliary Switch Example:

H F G 3 B 2 0 0 L **A 2** **X X X X**

Standard 9-digit Aux. Switch Completes Cat #

Shunt Trip / UVR Example:

H F G 3 B 2 0 0 L **X X** **U N** **X X**

Standard 9-digit UVR Completes Cat #

Shunt Trip / Auxiliary Switch Example:

H F G 3 B 2 0 0 L **A 2** **R N** **X X**

Standard 9-digit Aux. Switch Shunt Trip Completes Cat #

Non-Interchangeable Trip Breakers Example:

H F X 3 B 2 0 0 L

Standard 9-digit

1

2

3

4

5

6

7

8

9

10

11

12

13

14

15

16

17

General Application Molded Case Circuit Breakers

Catalog Numbering System

Selection/Application

If used on 250A frame and above means non-interchangeable trip breaker with factory assembled frame and trip. Solid state trip and current limiting (S or C in first character) are non-interchangeable only, and the "X" is omitted.

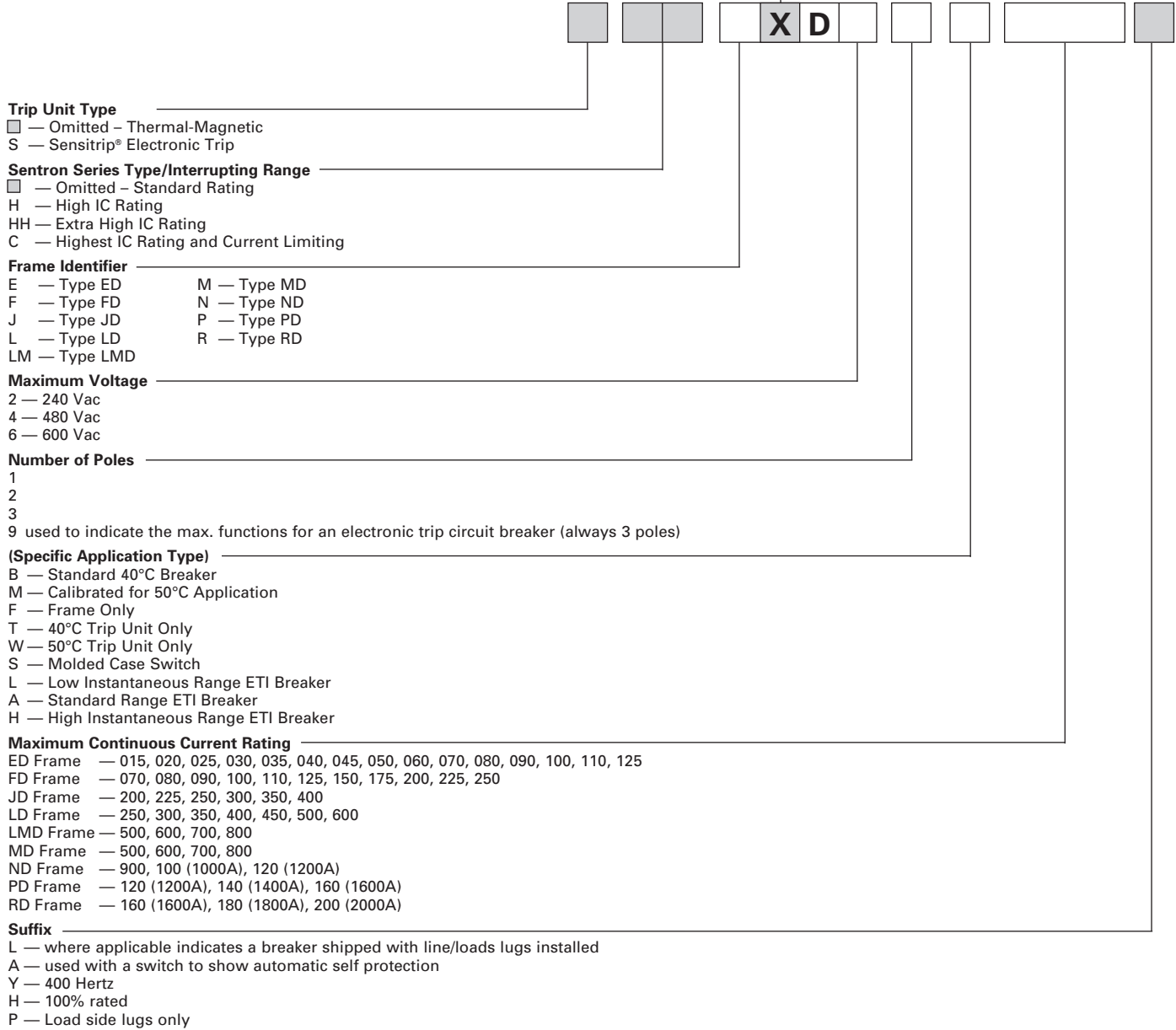

NOTE:

□ — Position omitted if not used.

General Application Molded Case Circuit Breakers

Lug-In/Lug-Out with INSTA-WIRE

Selection

All BQ/BQH/HBQ circuit breakers are supplied with load side lugs. If line side lugs are required, add suffix "L" to catalog number. Consult Siemens for any additional charge. All standard circuit breakers are calibrated for 40°C maximum ambient application.

Continuous Current Rating @ 40° C	Type BQ ^①	Type BQH	Type HBQ
	10,000A IR	22,000A IR	65,000A IR
	Catalog Number	Catalog Number	Catalog Number

1-Pole (120V AC)^⑤

Rating	Type BQ	Type BQH	Type HBQ
15	BQ1B015 ^④	BQ1B015H ^④	HB1B015 ^④
20	BQ1B020 ^④	BQ1B020H ^④	HB1B020 ^④
25	BQ1B025	BQ1B025H	HB1B025
30	BQ1B030	BQ1B030H	HB1B030
35	BQ1B035	BQ1B035H	HB1B035
40	BQ1B040	BQ1B040H	HB1B040
45	BQ1B045	BQ1B045H	HB1B045
50	BQ1B050	BQ1B050H	HB1B050
60	BQ1B060	BQ1B060H	HB1B060
70	BQ1B070	BQ1B070H	HB1B070

2-Pole (Common-Trip 120/240V AC)^⑥

Rating	Type BQ	Type BQH	Type HBQ
15	BQ2B015	BQ2B015H	HB2B015
20	BQ2B020	BQ2B020H	HB2B020
25	BQ2B025	BQ2B025H	HB2B025
30	BQ2B030	BQ2B030H	HB2B030
35	BQ2B035	BQ2B035H	HB2B035
40	BQ2B040	BQ2B040H	HB2B040
45	BQ2B045	BQ2B045H	HB2B045
50	BQ2B050	BQ2B050H	HB2B050
60	BQ2B060	BQ2B060H	HB2B060
70	BQ2B070	BQ2B070H	HB2B070
80	BQ2B080	BQ2B080H	HB2B080
90	BQ2B090	BQ2B090H	HB2B090
100	BQ2B100	BQ2B100H	HB2B100
110	BQ2B110	BQ2B110H	HB2B110
125	BQ2B125	BQ2B125H	HB2B125

2-Pole (Common-Trip 240V AC)^{③④}

Rating	Type BQ	Type BQH	Type HBQ
15	BQ2H015	—	—
20	BQ2H020	—	—
30	BQ2H030	—	—
40	BQ2H040	—	—
50	BQ2H050	—	—
60	BQ2H060	—	—
70	BQ2H070	—	—
80	BQ2H080	—	—
90	BQ2H090	—	—
100	BQ2H100	—	—

3-Pole (Common-Trip 240V AC)^⑦

Rating	Type BQ	Type BQH	Type HBQ
15	BQ3B015	BQ3B015H	HB3B015
20	BQ3B020	BQ3B020H	HB3B020
25	BQ3B025	BQ3B025H	HB3B025
30	BQ3B030	BQ3B030H	HB3B030
35	BQ3B035	BQ3B035H	HB3B035
40	BQ3B040	BQ3B040H	HB3B040
45	BQ3B045	BQ3B045H	HB3B045
50	BQ3B050	BQ3B050H	HB3B050
60	BQ3B060	BQ3B060H	HB3B060
70	BQ3B070	BQ3B070H	HB3B070
80	BQ3B080	BQ3B080H	HB3B080
90	BQ3B090	BQ3B090H	HB3B090
100	BQ3B100	BQ3B100H	HB3B100

BQ / BQH / HBQ Internal Accessories

Description	Catalog Number	Field/Factory Installed
120V Shunt Trip	add suffix...00S01	Factory
24V Shunt Trip	add suffix...00S07	Factory
120V Auxiliary Switch	add suffix...01	Factory

■ Built to order. Allow 2-3 weeks for delivery
 ① UL Listed for use with 60/75° wire through 40 amps, UL listed for use with 75° wire only for 50 amps and above, HACR rated.

② 1A and 1B contacts.
 ③ UL Listed for use on 3-phase grounded "B" systems — 10,000 for this application.
 ④ UL Listed for frequent switching applications (SWD). 120V AC Fluorescent Lighting.

⑤ Shipped 12 per sleeve.
 ⑥ Shipped 6 per sleeve.
 ⑦ Shipped 4 per sleeve.
 ⑧ UL Listed 5KA IR.

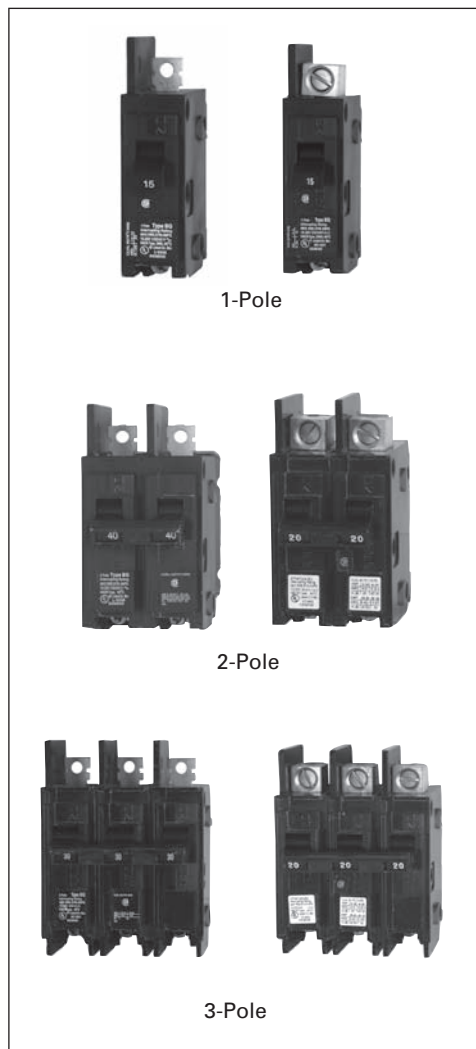

Factory Modifications

Description	Catalog Number
Line Side Lugs	add suffix...L
Quick Connect Lug	add suffix...QX
400Hz Calibration	add suffix...Y ^⑧
Marine 50° C Ambient Calibration	add suffix...M
Fungus Proofing	add suffix...F

For external accessories, please refer to page 17/106

1
2
3
4
5
6
7
8
9
10
11
12
13
14
15
16
17

General Application Molded Case Circuit Breakers

DIN Rail Mounted Circuit Breakers

Selection/Dimensions

Breaker Type	Ampere Rating	Catalog Number	Load Side Connector	Interrupting Ratings (KA) (RMS Symmetrical Amperes) Volts AC	
				120	120/240

1-Pole DIN Rail (120V AC)

BQXD 1-Pole 120V DIN Rail	10	BQ1B010QLD	TC1Q1	10	
	15	BQ1B015QLD	TC1Q1	10	
	20	BQ1B020QLD	TC1Q1	10	
	25	BQ1B025QLD	TC1Q1	10	
	30	BQ1B030QLD	TC1Q1	10	
	35	BQ1B035QLD	TC1Q1	10	
	40	BQ1B040QLD	TC1Q1	10	
	45	BQ1B045QLD	TA1Q1	10	
	50	BQ1B050QLD	TA1Q1	10	
	60	BQ1B060QLD	TA1Q1	10	
	10	BQ1B010QXD	Quick-Connect	10	
	15	BQ1B015QXD	Quick-Connect	10	
	20	BQ1B020QXD	Quick-Connect	10	
	25	BQ1B025QXD	Quick-Connect	10	
	30	BQ1B030QXD	Quick-Connect	10	
	35	BQ1B035QXD	Quick-Connect	10	
	40	BQ1B040QXD	Quick-Connect	10	
	45	BQ1B045QXD	Quick-Connect	10	
50	BQ1B050QXD	Quick-Connect	10		
60	BQ1B060QXD	Quick-Connect	10		

2-Pole DIN Rail (120/240V AC)

BQXD 2-Pole 120/240V DIN Rail	10	BQ2B010QLD	TC1Q1		10
	15	BQ2B015QLD	TC1Q1		10
	20	BQ2B020QLD	TC1Q1		10
	25	BQ2B025QLD	TC1Q1		10
	30	BQ2B030QLD	TC1Q1		10
	35	BQ2B035QLD	TC1Q1		10
	40	BQ2B040QLD	TC1Q1		10
	45	BQ2B045QLD	TA1Q1		10
	50	BQ2B050QLD	TA1Q1		10
	60	BQ2B060QLD	TA1Q1		10
	10	BQ2B010QXD	Quick-Connect		10
	15	BQ2B015QXD	Quick-Connect		10
	20	BQ2B020QXD	Quick-Connect		10
	25	BQ2B025QXD	Quick-Connect		10
	30	BQ2B030QXD	Quick-Connect		10
	35	BQ2B035QXD	Quick-Connect		10
	40	BQ2B040QXD	Quick-Connect		10
	45	BQ2B045QXD	Quick-Connect		10
50	BQ2B050QXD	Quick-Connect		10	
60	BQ2B060QXD	Quick-Connect		10	

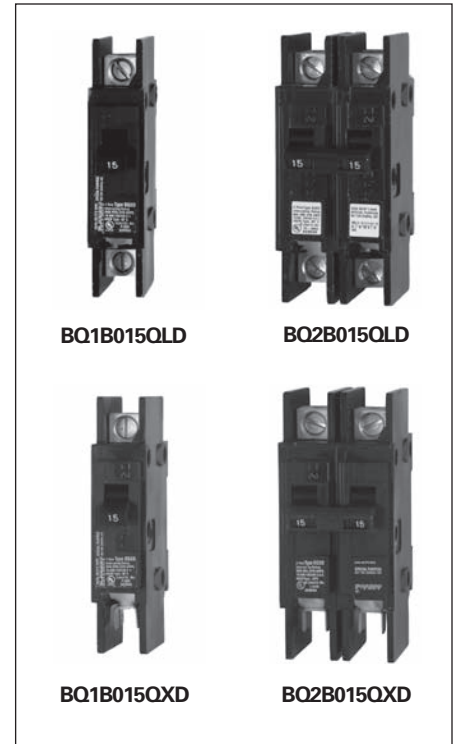

Lugs-For Use with BQ, BQH, HBQ[Ⓢ]

Circuit Breaker Amp. Rtg.	Cab. Per Lug	Lug Wire Range AWG	Catalog Number
Line Side			
10-40	1	#16-#6 Cu #12-#6 Al	TC1Q1 [Ⓢ]
45-125	1	#8-#1 Cu #6-#1/0 Al	TA1Q1
Load Side			
10	2	#16 Cu	Connectors are Supplied with Circuit Breaker
15-20	1	#14-#10 Cu #12-#10 Al	
25-35	1	#14-#6 Cu #12-#10 Al	
40-50	1	#8-#6 Cu #8-#4 Al	
55-70	1	#8-#4 Cu #8-#2 Al	
80-100	1	#4-#1/0 Cu #2-#1/0 Al	
110-125	1	#2-#1/0 Cu #1/0-#2/0 Al	

For inches / millimeters conversion, see Application Data section.

■ Built to order. Allow 2-3 weeks for delivery.

Ⓢ UL Listed for use with 60/75° wire through 40 amps, UL listed for use with 75° wire only for 50 amps and above, HACR rated.

Finger Safe Terminal Shield

Protects against accidental contact with lugs-1 per lug. Fits line and load end.

Catalog Number	Qty
BQFS2	2
BQFS1K	1000

Enclosures	
Type	Catalog Number [Ⓢ]
1	EB3100S[Ⓢ]
3R	WB3100

Ⓢ Connector has steel construction.

Ⓢ Surface mounted indoor. If flush mounting is required, replace suffix "S" in catalog number with suffix "F".

Ⓢ Neutral included in enclosure.

Ⓢ Enclosure will not accept circuit breakers with shunt trips or auxiliary switches installed.

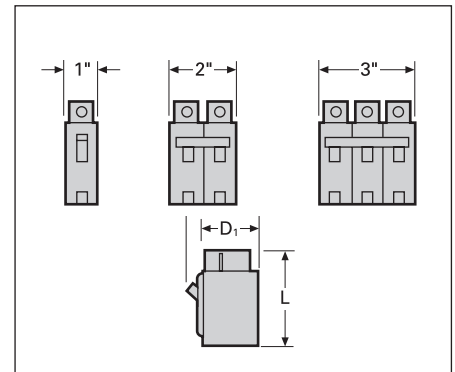

Breaker Type	Amperes	Dimensions (inches)		
		L	D1	D2
BQ, BQH	15-50	3 3/4	2 3/8	3
BQ, BQH	55-125	4	2 3/8	3
HBQ	15-125	4	2 3/8	3
BQXD	15-60	4 1/2	2 3/8	3

Ⓢ Type BQXD uses TA1Q1 or TC1Q1 lugs on line side of circuit breaker.

For external accessories, please refer to pages 17/106, 17/108 to 17/113

General Application Molded Case Circuit Breakers

QJ 225A Frame

Selection/Dimensions

Continuous Current Rating @ 40°C	2-Pole 240V AC Catalog Number	3-Pole 240V AC Catalog Number
----------------------------------	-------------------------------	-------------------------------

Type QJ2^②

Current Rating	2-Pole Catalog Number	3-Pole Catalog Number
60	QJ22B060■	QJ23B060
70	QJ22B070■	QJ23B070
80	QJ22B080■	QJ23B080■
90	QJ22B090■	QJ23B090■
100	QJ22B100	QJ23B100
110	QJ22B110■	QJ23B110
125	QJ22B125	QJ23B125
150	QJ22B150	QJ23B150
175	QJ22B175	QJ23B175
200	QJ22B200	QJ23B200
225	QJ22B225	QJ23B225

Type QJH2^②

Current Rating	2-Pole Catalog Number	3-Pole Catalog Number
60	QJH22B060■	QJH23B060■
70	QJH22B070■	QJH23B070■
80	QJH22B080■	QJH23B080■
90	QJH22B090■	QJH23B090■
100	QJH22B100■	QJH23B100
110	QJH22B110■	QJH23B110
125	QJH22B125	QJH23B125
150	QJH22B150	QJH23B150
175	QJH22B175■	QJH23B175
200	QJH22B200	QJH23B200
225	QJH22B225	QJH23B225

Type QJ2H^②

Current Rating	2-Pole Catalog Number	3-Pole Catalog Number
60	QJ22B060H■	QJ23B060H■
70	QJ22B070H■	QJ23B070H■
80	QJ22B080H■	QJ23B080H■
90	QJ22B090H■	QJ23B090H■
100	QJ22B100H■	QJ23B100H
110	QJ22B110H■	QJ23B110H■
125	QJ22B125H	QJ23B125H
150	QJ22B150H	QJ23B150H
175	QJ22B175H■	QJ23B175H
200	QJ22B200H	QJ23B200H
225	QJ22B225H	QJ23B225H

Type HQJ2^②

Current Rating	2-Pole Catalog Number	3-Pole Catalog Number
100	—	HQJ23B100▲
110	—	HQJ23B110▲
125	—	HQJ23B125▲
150	—	HQJ23B150▲
175	—	HQJ23B175▲
200	—	HQJ23B200▲
225	—	HQJ23B225▲

QJ2

Internal Accessories (Factory installed only) (3-pole only)^③
Add suffix to catalog number.

Control Voltage		Shunt Trip	Auxiliary Switches		Shunt Trip and 1A and 1B Auxiliary Switch
AC	DC		1A and 1B	2A and 2B	
120/240		Suffix	Suffix	Suffix	Suffix
		00S01■	A01■	A02■	01S01■
	24	00S07■	A01■	A02■	01S07■
	48	00S09■	A01■	A02■	01S09■

Ordering Information

Load side TA1Q300 lugs are mounted and included when circuit breaker is ordered. For line and load lugs (TA1Q300) installed at no additional charge, add suffix "L" to catalog number.

50°C Calibration - See page 17/104.
400HZ. - See page 17/104.

Shipping Weights

QJ2, QJH2, QJ2H, HQJ2		
Number of Poles	Number per Carton	Shipping Weight (lbs.)
2	10	30
3	10	41

Lugs For 75°C Wire^①

Catalog Number	Lug Body	Lug Wire Range
TA1Q300	Al	(1) #6—300 kcmil Cu (1) #4—300 kcmil Al
TC1Q250	Cu	(1) #6—250 kcmil Cu

Enclosures (Neutral Included)

Type	Catalog Number
1	EB3225(S)(F)
3R (2-pole)	WB2225
3R (3-pole)	WB3225

UL 489 Interrupting Ratings

Breaker Type	RMS Symmetrical Amperes (kA)	
	240 Volts AC (50/60 Hz)	208Y/120
QJ2	10	—
QJH2	22	—
QJ2H	42	—
HQJ2	65	100

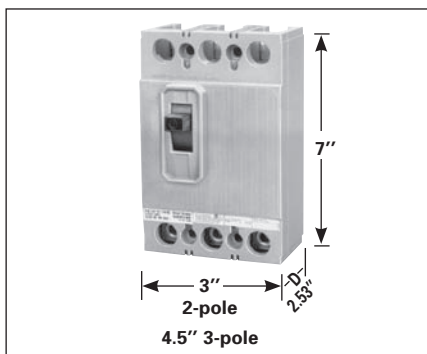

■ Built to order. Allow 2–3 weeks for delivery.

▲ Built to order. Allow 6–8 weeks for delivery.

① See Note: A page 17/42.

Note: QJ breakers are UL Listed for reverse feed applications.

② HACR rated.

③ Internal accessories are not available on 2-pole QJ breakers.

For external accessories, please refer to pages 17/108 to 17/113

General Application Molded Case Circuit Breakers

CQD 100A Frame

Selection/Dimensions

Type CQD (Cable In - Cable Out) DIN Rail Mount[Ⓢ]

Continuous Current Rating @ 40°C	1-Pole	2-Pole	3-Pole
	277V AC 125V DC	480Y/277V AC 125/250V DC	480Y/277V AC
	Catalog Number	Catalog Number	Catalog Number
15	CQD115 [Ⓢ]	CQD215 [Ⓢ]	CQD315 [Ⓢ]
20	CQD120 [Ⓢ]	CQD220 [Ⓢ]	CQD320 [Ⓢ]
25	CQD125 [Ⓢ]	CQD225 [Ⓢ]	CQD325 [Ⓢ]
30	CQD130 [Ⓢ]	CQD230 [Ⓢ]	CQD330 [Ⓢ]
35	CQD135 [■]	CQD235 [■]	CQD335 [Ⓢ]
40	CQD140 [■]	CQD240 [Ⓢ]	CQD340 [Ⓢ]
45	CQD145 [■]	CQD245 [■]	CQD345 [■]
50	CQD150 [■]	CQD250 [Ⓢ]	CQD350 [Ⓢ]
60	CQD160 [■]	CQD260	CQD360
70	CQD170 [■]	CQD270	CQD370
80	CQD180 [■]	CQD280	CQD380
90	CQD190 [■]	CQD290 [■]	CQD390
100	CQD1100 [■]	CQD2100	CQD3100

Shipping Weights

Number of Poles	Number per Carton	Shipping Weight lbs. (kg)
1	1	0.5 (0)
2	1	1.0 (0)
3	1	1.5 (1)

Lugs For 60/75°C Wire

Amps	Wire Size
15-40	#14-#6 AWG Cu #12-#6 AWG Al
45-100	#8-#1 AWG Cu #6-#1/0 AWG Al

Type CQD6 (Cable In - Cable Out) CSA Certified, not UL

Continuous Current Rating @ 40°C	1-Pole	2-Pole	3-Pole
	347V AC 125V DC	600Y/347V AC 125/250V DC	600Y/347V AC
	Catalog Number	Catalog Number	Catalog Number
15	—	CQD6215 [■]	CQD6315 [■]
20	CQD6120 [Ⓢ]	CQD6220 [■]	CQD6320 [■]
25	CQD6125 [Ⓢ]	CQD6225 [■]	CQD6325 [■]
30	CQD6130 [Ⓢ]	CQD6230 [■]	CQD6330 [■]
35	CQD6135 [■]	CQD6235 [■]	CQD6335 [■]
40	CQD6140 [■]	CQD6240 [■]	CQD6340 [■]
45	CQD6145 [■]	CQD6245 [■]	CQD6345 [■]
50	CQD6150 [■]	CQD6250 [■]	CQD6350 [■]
60	CQD6160 [■]	CQD6260 [■]	CQD6360 [■]
70	CQD6170 [■]	CQD6270 [■]	—

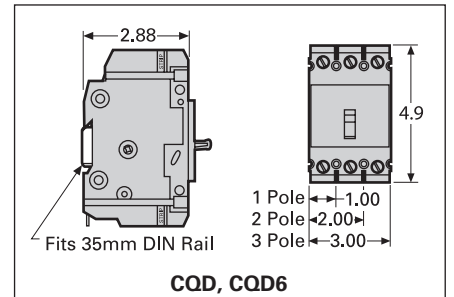
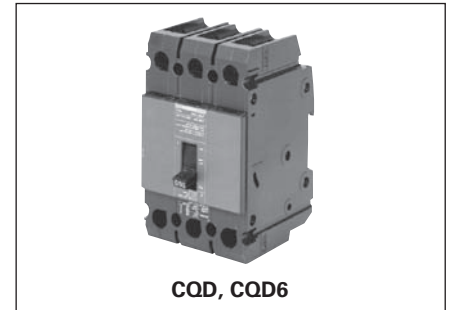

Interrupting Ratings

Breaker Type	Number of Poles	RMS Symmetrical Amperes (KA)						
		Volts AC (50/60 Hz)					Volts DC	
		120	240	277	480/277	600/347	125	125/250
CQD (UL)	1	65	—	14	—	—	14	—
	2	—	65	—	14	—	—	14
	3	—	65	—	14	—	—	—
CQD6 (CSA)	1	65	—	14	—	10	14	—
	2	—	65	—	—	10	—	14
	3	—	65	—	—	10	—	—

For inches / millimeters conversion, see Application Data section.

■ Built to order. Allow 2-3 weeks for delivery.

Ⓢ HID rated.

Ⓢ SWD rated.

Ⓢ HACR rated.

Note: CQD breakers are UL Listed for reverse feed applications.

Accessories pages 17/14 and 17/108 to 17/113

General Application Molded Case Circuit Breakers

GG 125A Frame

Selection/Dimensions

GG 125A Frame (Cable In - Cable Out)

Continuous Current Rating @ 40°C	1-Pole	2-Pole	3-Pole
	Catalog Number	Catalog Number	Catalog Number
15	NGG1B015L ^{①②}	NGG2B015L ^②	NGG3B015L ^②
20	NGG1B020L ^{①②}	NGG2B020L ^②	NGG3B020L ^②
25	NGG1B025L ^②	NGG2B025L ^②	NGG3B025L ^②
30	NGG1B030L ^②	NGG2B030L ^②	NGG3B030L ^②
35	NGG1B035L ^②	NGG2B035L ^②	NGG3B035L ^②
40	NGG1B040L ^②	NGG2B040L ^②	NGG3B040L ^②
45	NGG1B045L ^②	NGG2B045L ^②	NGG3B045L ^②
50	NGG1B050L ^②	NGG2B050L ^②	NGG3B050L ^②
60	NGG1B060L	NGG2B060L	NGG3B060L
70	NGG1B070L	NGG2B070L	NGG3B070L
80	NGG1B080L	NGG2B080L	NGG3B080L
90	NGG1B090L	NGG2B090L	NGG3B090L
100	NGG1B100L	NGG2B100L	NGG3B100L
110	NGG1B110L	NGG2B110L	NGG3B110L
125	NGG1B125L	NGG2B125L	NGG3B125L

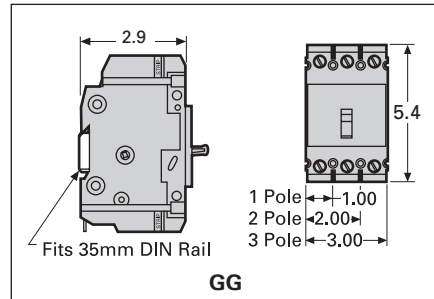

Line and load lugs are included as standard. If no lugs are required, remove the "L" suffix. HACR rated. Suitable for screws or DIN rail mounting.

Type HGG (Cable In - Cable Out)

Continuous Current Rating @ 40°C	1-Pole	2-Pole	3-Pole
	Catalog Number	Catalog Number	Catalog Number
15	HGG1B015L ^{①②}	HGG2B015L ^②	HGG3B015L ^②
20	HGG1B020L ^{①②}	HGG2B020L ^②	HGG3B020L ^②
25	HGG1B025L ^②	HGG2B025L ^②	HGG3B025L ^②
30	HGG1B030L ^②	HGG2B030L ^②	HGG3B030L ^②
35	HGG1B035L ^②	HGG2B035L ^②	HGG3B035L ^②
40	HGG1B040L ^②	HGG2B040L ^②	HGG3B040L ^②
45	HGG1B045L ^②	HGG2B045L ^②	HGG3B045L ^②
50	HGG1B050L ^②	HGG2B050L ^②	HGG3B050L ^②
60	HGG1B060L	HGG2B060L	HGG3B060L
70	HGG1B070L	HGG2B070L	HGG3B070L
80	HGG1B080L	HGG2B080L	HGG3B080L
90	HGG1B090L	HGG2B090L	HGG3B090L
100	HGG1B100L	HGG2B100L	HGG3B100L
110	HGG1B110L	HGG2B110L	HGG3B110L
125	HGG1B125L	HGG2B125L	HGG3B125L

Type LGG (Cable In - Cable Out)

Continuous Current Rating @ 40°C	1-Pole	2-Pole	3-Pole
	Catalog Number	Catalog Number	Catalog Number
15	LGG1B015L ^{①②}	LGG2B015L ^②	LGG3B015L ^②
20	LGG1B020L ^{①②}	LGG2B020L ^②	LGG3B020L ^②
25	LGG1B025L ^②	LGG2B025L ^②	LGG3B025L ^②
30	LGG1B030L ^②	LGG2B030L ^②	LGG3B030L ^②
35	LGG1B035L ^②	LGG2B035L ^②	LGG3B035L ^②
40	LGG1B040L ^②	LGG2B040L ^②	LGG3B040L ^②
45	LGG1B045L ^②	LGG2B045L ^②	LGG3B045L ^②
50	LGG1B050L ^②	LGG2B050L ^②	LGG3B050L ^②
60	LGG1B060L	LGG2B060L	LGG3B060L
70	LGG1B070L	LGG2B070L	LGG3B070L
80	LGG1B080L	LGG2B080L	LGG3B080L
90	LGG1B090L	LGG2B090L	LGG3B090L
100	LGG1B100L	LGG2B100L	LGG3B100L
110	LGG1B110L	LGG2B110L	LGG3B110L
125	LGG1B125L	LGG2B125L	LGG3B125L

Shipping Weights

Number of Poles	Number per Carton	Shipping Weight lbs. (kg)
1	1	.75 (0.34)
2	1	1.3 (0.59)
3	1	2.0 (0.98)

Lugs For 60/75°C Wire

NGG		
Ampere Rating	Wire Size	Catalog Number
15-30A	#14-#6 AWG Cu	TC1Q1 (qty. 1)
	#12-#6 AWG Al	3TC1Q1 (qty. 3)
35-125A	#8-1/0 AWG Cu #8-2/0 AWG Al	3TC1GG20 (qty. 3)
15-125A	Nut Keeper plate w/ screw (for crimp terminals)	TNKG3 (qty. 3)

Interrupting Ratings (max. RMS symmetrical amperes kA)

Breaker Type	Poles	UL489							IEC 60947-2 (Ics = 50%Icu)			
		Volts AC							Volts AC			
		120	240	277	347	480	600Y/347	125	125/250	240	415	125/250
NGG	1	65	—	25	14	—	—	14	—	25	—	—
	2,3	—	65	—	—	25	14	—	14 ^①	65	—	14
HGG	1	65	—	35	14	—	—	14	—	—	—	—
	2,3	—	65	—	—	35	14	—	14 ^①	—	—	14
LGG	1	65	—	65	14	—	—	14	—	—	—	—
	2,3	—	65	—	—	65	14	—	14 ^①	—	—	14

For inches / millimeters conversion, see Application Data section.

① SWD rated.

② HID rated at 15-50A 1-pole @ 277 VAC; 2 & 3-pole @ 480 VAC

Accessories pages 17/14 and 17/108 to 17/113

General Application Molded Case Circuit Breakers Accessories^①

Selection

Shunt Trip

Control Voltage		Catalog Number
V AC	V DC	
120	—	CQDST120
240	—	CQDST240▲
277	—	CQDST277▲
480	—	CQDST480▲
600	—	CQDST600
—	12	CQDST12
—	24	CQDST24
—	48	CQDST48
—	125	CQDST125

Auxiliary Switch

Maximum Voltage		Number of Contacts	Catalog Number
AC	DC		
240	125	1A-1B	CQDA1
240	125	2A-2B	CQDA2

Alarm Switch

Maximum Voltage		Catalog Number
AC	DC	
240	125	CQDBA

Shunt Trip and Auxiliary Switch Combinations

Shunt Trip Voltage		Catalog Number
AC	DC	
24	—	CQDST24AAS▲
120	—	CQDST120AAS▲
240	—	CQDST240AAS▲
277	—	CQDST277AAS▲
480	—	CQDST480AAS▲
600	—	CQDST600AAS▲
—	12	CQDST12DAS▲
—	24	CQDST24DAS▲
—	48	CQDST48DAS▲
—	125	CQDST125DAS▲

Alarm and Auxiliary Switch Combinations

For Breaker	Catalog Number
BQD, BQD6, CQD, CQD6, NGG, HGG, LGG, NGB, HGB and LGB	CQDA1BA▲

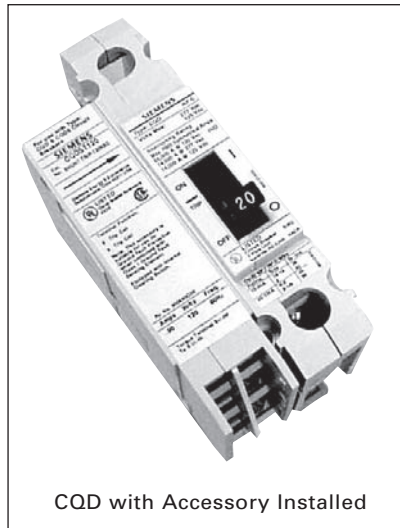

CQD with Accessory Installed

▲ Built to order. Allow 6-8 weeks for delivery.

① Adds 1-pole space for accessory.

The interchangeability of the VL circuit breaker trip units allow for easy conversion from any of 3 types of protection. They are thermal-magnetic, electronic, or electronic with a built-in LCD. The thermal-magnetic trip unit features an adjustable magnetic trip setting. The electronic trip units are microprocessor based true RMS sensing devices and are available with a variety of adjustable trip settings, configurations, and infor-

mation menus. With precise control over the circuit breaker functions and access to system status, diagnostics, and information, these trip units allow for unsurpassed flexibility in circuit coordination.

An example of coordination is the out of the box Ground Fault function on the Model 555 trip units. The pick-up and time delay settings are set at the

factory for each frame and do not overlap with the settings on the other frames. Therefore, when VL breakers are used together in a system the GF protection is automatically coordinated. The user also has the ability to program a custom coordination scheme with adjustable settings on both the 555 and 586 trip units.

Trip Unit Functions	VL Trip Units							
	Model 525	Model 555				Model 586		
	Thermal-magnetic	Electronic LI	Electronic LIG	Electronic LSI	Electronic LSIG	Electronic with LCD LSI	Electronic with LCD LSIG	Electronic with LCD LSI + G alarm only
Continuous Current Setting (I_r)	Fixed	◆	◆	◆	◆	◆	◆	◆
Long Time Delay (t_r)	□	◆	◆	◆	◆	◆	◆	◆
Instantaneous Function	●	●	●	●	●	(ON/OFF)	(ON/OFF)	(ON/OFF)
Instantaneous Pickup (I_i)	◆	◆	◆	◆	◆	◆	◆	◆
Short Time Function	□	□	□	●	●	(ON/OFF)	(ON/OFF)	(ON/OFF)
Short Time Pick-up (I_{sd})	□	□	□	◆	◆	◆	◆	◆
Short Time Delay (t_{sd})	□	□	□	◆	◆	◆	◆	◆
Ground Fault Pick-up (I_g)	□	□	◆	□	◆	□	◆	□
Ground Fault Delay (t_g)	□	□	◆	□	◆	□	◆	□
Ground Fault Alarm Pick-up	□	□	□	□	□	□	◆	◆
Ground Fault Alarm Delay	□	□	□	□	□	□	◆	◆
Alarm & Status Indicator	□	●	●	●	●	●	●	●
Built-in Display (LCD)	□	□	□	□	□	●	●	●
Pre-Trip Alarm ^①	□	●	●	●	●	●	●	●
Last Trip Information	□	● ^①	● ^①	● ^①	● ^①	●	●	●
Zone Selective ^①	□	●	●	●	●	●	●	●
Communications ^①	□	●	●	●	●	●	●	●

◆ Adjustable setting
 ● This feature is included
 □ Feature is not included.
 ① Requires a COMPRO20 or COMM021 module in a communication system.

Continuous Amps Rating (I_r)

This setting is the continuous current that the breaker will carry without tripping. It can be set up to 100% of the trip unit's nominal rating (I_n).

Long Time Delay (t_r)

Sometimes referred to as the "overload" position, this function controls the breaker's "pause-in-tripping" time. It allows low level, temporary inrush currents such as those encountered when starting a motor to pass without tripping. The time delay begins when the current reaches $6 \times I_r$.

Instantaneous Pick-up (I_i)

This function sets the breaker to trip instantaneously during high fault conditions. This function may be turned off on Model 586 trip units. Turning this function off will enable an instantaneous trip

override function to ensure self protection of circuit breaker.

Short Time Pick-Up (I_{sd})

This function controls the level of fault current the breaker will carry for a short time without tripping, thus allowing downstream devices to clear short circuits ahead of up-stream protection. It may be defeated (turned-off) on Model 586 trip units.

Short Time Delay (t_{sd})

This controls the interval of time the breaker will remain closed against a fault (at the Short Time Pick-up current level) without tripping. The time delay may be set at fixed points or at short time intervals based on I^2t curves. This function is used with the Short Time Pick-up to achieve selectivity and better system coordination.

Ground Fault Pick-Up (I_g)

This setting controls the level of ground fault current that will cause the breaker to trip. Model 555 Electronic Trip Units act on the residual current to sense ground current. The Model 586 Electronic Trip Unit is programmable and allows the user to select either the residual current method or direct detection (via a separate current transformer) to detect ground current.

Ground Fault Time Delay (t_g)

This controls the interval of time the breaker will remain closed after a ground fault is detected (at the Ground Fault Pick-up current level) without tripping.

VL Molded Case Circuit Breakers

General Information

Selection

Thermal-Magnetic trip units, Model 525, combine the inverse time element design for low level overloads, and instantaneous magnetic action for short circuit protection. The standard unit has preset overload protection and an adjustable instantaneous trip setting, with 6 set points. Thermal-Magnetic trip units are available throughout the VL family, from 50 to 1600A.

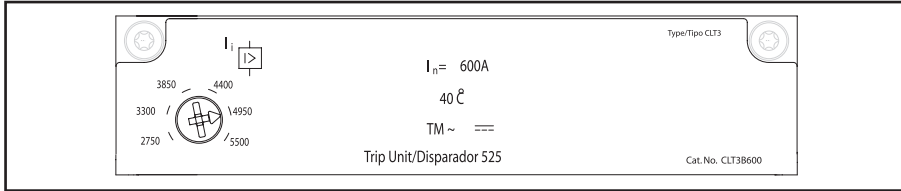

Electronic Trip Units

Electronic trip units are available through the VL family, from 60A (which can be set as low as 30A) up through 1600A. They are also available in four trip configurations (LI, LIG, LSI, LSIG) and features can include a built-in LCD display.

microprocessor is in operating and another indicates an overload condition. For ease-of-use and to insure proper coordination, the set points for the continuous current are shown on the face of these trip units [in amps](#).

displays, no secondary or auxiliary voltage is required as long as the breaker is energized and a minimal load current is present. These trip units can also indicate the "last trip" status (date, time, amps) when they're connected to a PC via one of our communications modules. Without being connected via a communication module, the last trip status can be viewed on Model 586 trip units (no time stamp).

On the Model 555 Electronic Trip Unit a flashing LED confirms that the

On the Model 586, the LCD version, the current in each phase is continuously shown on the display. Unlike many

Typical Trip Unit Labeling and Adjustment Positions

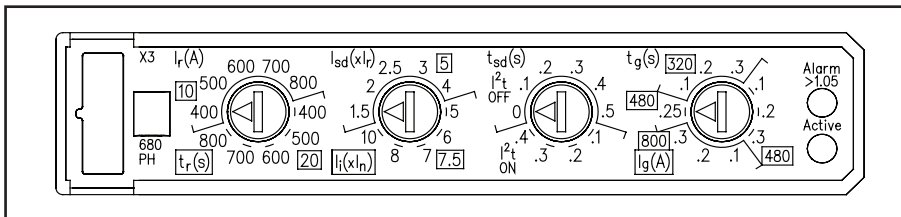

Model 555 Electronic Trip Unit with LSIG trip functions

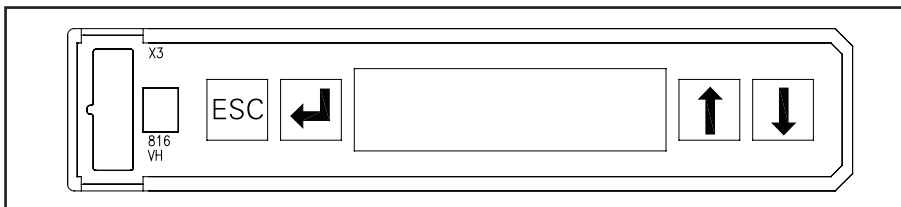

Model 586 Electronic Trip Unit has an LCD display

VL Molded Case Circuit Breakers

DG 150A Frame, VL Series

Selection

1
2
3
4
5
6
7
8
9
10
11
12
13
14
15
16
17

Ordering Information

Complete Assembled Breaker

A complete factory assembled DG breaker includes the frame, trip unit, and standard line and load connectors, all factory installed and shipped as a complete breaker. Assembled breakers are only available with standard connectors.

For DC applications, use thermal magnetic trip unit only.

Breakers are suitable for reverse feed applications.

For special applications, refer to page 17/62.

Mounting hardware is included with each frame or complete breaker.

For 100% rated breakers with a non-interchangeable trip unit, change the 3rd character of the catalog number to "W". Available in electronic and electronic with LCD only.

HACR rated.

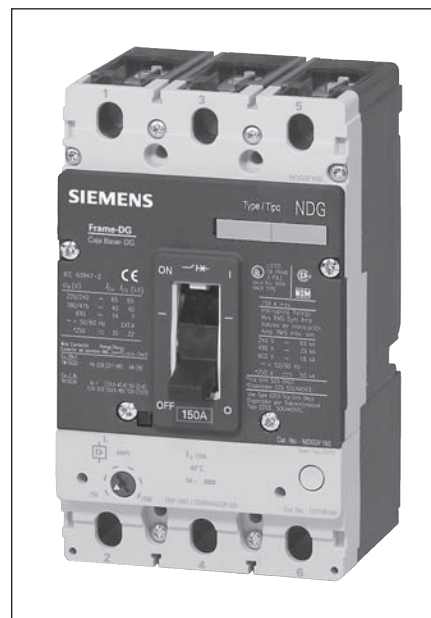

Interrupting Ratings

Interrupting Class	Breaker Type	RMS Symmetrical Amperes (KA)										
		UL 489					IEC 60947-2					
		Volts AC (50/60 Hz)			Volts DC		Volts AC (50/60 Hz)					
		240	480	600Y/347	250	500	220/240		380/415		690	
N	NDGB	65	35	18	30	18	65	65	40	40	12	6
H	HDGB	100	65	18	30	18	100	75	70	70	12	6
L	LDGB	200	100	18	30	18	200	150	100	75	12	6

Dimensions, inches (mm)

Number of Poles	Width	Length	Depth	To Handle D1
2, 3	4.1 (105)	6.9 (175)	3.4 (81)	4.2(107)

Connectors for 75°C Wire

Construction	Ampere Rating	Wire Range	No. of cables per connector	Catalog Number
Steel	30-150	#8-1/0 Cu	1	3TW1DG20 ^②
Aluminum	30-150	#6-3/0 Al/Cu	1	3TA1DG30 ^{①②}
Copper	30-150	#6-3/0 Cu	1	3TC1DG30 ^{②④}
Distribution Lugs				
	30-150	#14-#2 Al/Cu (3pcs. Max)	3	3TA3DG02 ^②
	30-150	#14-#4 Cu, #14-#6 Al	6	3TA6DG04 ^②
Compression Lugs				
	30-150	#14-2/0 kcmil Al/Cu	-	2CLD20 ^③
	30-150	#14-2/0 kcmil Al/Cu	-	3CLD20 ^②

- ① Standard connector supplied with complete breakers.
- ② Kit consists of 3 terminal connectors.
- ③ 2 Lugs for 2-pole breakers.
- ④ Required for 100% rated DG breakers. Requires 90°C Cu cable sized at 75°C ampacity

Approx. Shipping Weight, lbs. (kg)

Poles	Frame	Trip Unit		Complete Breaker
		Thermal-Mag.	Electronic	
2, 3	3.7 (1.7)	2.2 (1.0)	2.6 (1.2)	5.9 (2.7)

DG Thermal-Magnetic, Instantaneous Trip Adjustment Range

Trip Unit Continuous Amp Rating (I _n)	Instantaneous Overcurrent Setting (I _t)	
	Min.	Max.
50	450	600
60	450	600
70	450	700
80	450	800
90	500	1000
100	500	1000
110	550	1100
125	625	1250
150	800	1600

Note: Each breaker has 6 trip settings in this range.

External Accessories pages 17/43 through 17/57

VL Molded Case Circuit Breakers

DG 150A Thermal-Magnetic Trip Unit

Selection

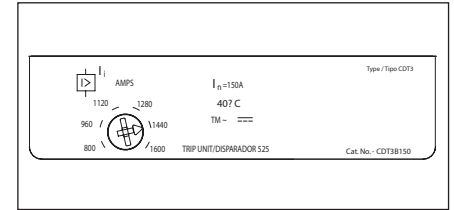

Model 525 Trip Unit

DG 150A Frame 2-Pole with Thermal-Magnetic Trip Unit

Continuous Ampere Rating	COMPLETE FACTORY ASSEMBLED CIRCUIT BREAKER		
	N-Interrupting Class	H-Interrupting Class	L-Interrupting Class
	Catalog Number	Catalog Number	Catalog Number
50	NDK2B050L	HDK2B050L	LDK2B050L
60	NDK2B060L	HDK2B060L	LDK2B060L
70	NDK2B070L	HDK2B070L	LDK2B070L
80	NDK2B080L	HDK2B080L	LDK2B080L
90	NDK2B090L	HDK2B090L	LDK2B090L
100	NDK2B100L	HDK2B100L	LDK2B100L
110	NDK2B110L	HDK2B110L	LDK2B110L
125	NDK2B125L	HDK2B125L	LDK2B125L
150	NDK2B150L	HDK2B150L	LDK2B150L

DG 150A Frame 3-Pole with Thermal-Magnetic Trip Unit

Continuous Ampere Rating	COMPLETE FACTORY ASSEMBLED CIRCUIT BREAKER		
	N-Interrupting Class	H-Interrupting Class	L-Interrupting Class
	Catalog Number	Catalog Number	Catalog Number
50	NDK3B050L	HDK3B050L	LDK3B050L
60	NDK3B060L	HDK3B060L	LDK3B060L
70	NDK3B070L	HDK3B070L	LDK3B070L
80	NDK3B080L	HDK3B080L	LDK3B080L
90	NDK3B090L	HDK3B090L	LDK3B090L
100	NDK3B100L	HDK3B100L	LDK3B100L
110	NDK3B110L	HDK3B110L	LDK3B110L
125	NDK3B125L	HDK3B125L	LDK3B125L
150	NDK3B150L	HDK3B150L	LDK3B150L

A - Consult with Siemens for availability.

VL Molded Case Circuit Breakers

DG 150A Electronic Trip Units

Selection

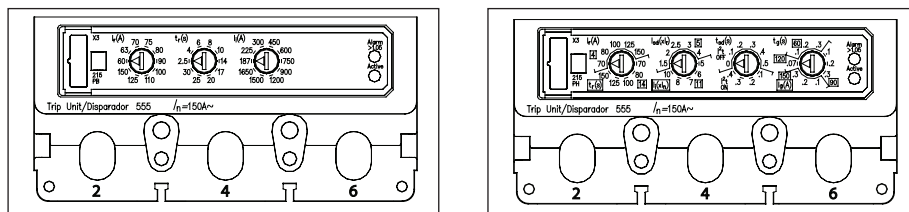

Model 555 Trip Units

DG 150A Frame 3-Pole Electronic Trip Unit^①

Continuous Ampere Rating	COMPLETE FACTORY ASSEMBLED CIRCUIT BREAKER		
	N-Interrupting Class	H-Interrupting Class	L-Interrupting Class
	Catalog Number	Catalog Number	Catalog Number
ELECTRONIC LI TRIP			
60	NDK3R060L	HDK3R060L	LDK3R060L
100	NDK3R100L	HDK3R100L	LDK3R100L
150	NDK3R150L	HDK3R150L	LDK3R150L
ELECTRONIC LSI TRIP			
60	NDK3T060L	HDK3T060L	LDK3T060L
100	NDK3T100L	HDK3T100L	LDK3T100L
150	NDK3T150L	HDK3T150L	LDK3T150L
ELECTRONIC LSIG TRIP			
60	NDK3V060L	HDK3V060L	LDK3V060L
100	NDK3V100L	HDK3V100L	LDK3V100L
150	NDK3V150L	HDK3V150L	LDK3V150L
ELECTRONIC LIG TRIP			
60	NDK3W060L	HDK3W060L	LDK3W060L
100	NDK3W100L	HDK3W100L	LDK3W100L
150	NDK3W150L	HDK3W150L	LDK3W150L

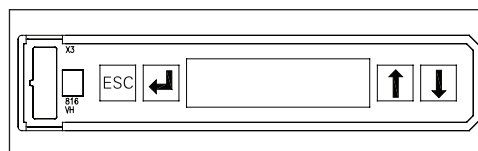

Model 586 Trip Unit

DG 150A Frame 3-Pole Electronic LCD Trip Unit^①

Continuous Ampere Rating	COMPLETE FACTORY ASSEMBLED CIRCUIT BREAKER		
	N-Interrupting Class	H-Interrupting Class	L-Interrupting Class
	Catalog Number	Catalog Number	Catalog Number
LCD ELECTRONIC LSI TRIP			
60	NDK3A060L	HDK3A060L	LDK3A060L
100	NDK3A100L	HDK3A100L	LDK3A100L
150	NDK3A150L	HDK3A150L	LDK3A150L
LCD ELECTRONIC LSIG TRIP			
60	NDK3G060L	HDK3G060L	LDK3G060L
100	NDK3G100L	HDK3G100L	LDK3G100L
150	NDK3G150L	HDK3G150L	LDK3G150L
LCD ELECTRONIC LSI TRIP + GF ALARM ONLY			
60	NDK3K060L	HDK3K060L	LDK3K060L
100	NDK3K100L	HDK3K100L	LDK3K100L
150	NDK3K150L	HDK3K150L	LDK3K150L

^① Due to the location of the magnetic tripping solenoid, the left accessory pocket is not available for accessories.

VL Molded Case Circuit Breakers

FG 250A Frame, VL Series

Selection/Dimensions

Ordering Information

Complete Assembled Breaker

A complete factory assembled FG breaker includes the frame, trip unit, and standard line and load connectors, all factory installed and shipped as a complete breaker. Assembled breakers are available only with standard connectors.

For DC applications, use thermal magnetic trip unit only.

Breakers are suitable for reverse feed applications.

For special applications, refer to page 17/62.

Mounting hardware is included with each frame or complete breaker.

HACR rated.



Interrupting Ratings

Breaker Type	RMS Symmetrical Amperes (KA)										
	UL 489					IEC 60947-2					
	Volts AC (50/60 Hz)			Volts DC		Volts AC (50/60 Hz)					
	240	480	600 ^①	250	500	220/240		380/415		690	
					I _{CU}	I _{CS}	I _{CU}	I _{CS}	I _{CU}	I _{CS}	
NFG	65	35	18	30	18	65	65	40	40	12	6
HFG	100	65	20	30	25	100	75	70	70	12	6
LFG	200	100	25	30	30	200	150	100	75	12	6

Dimensions, inches (mm)

Number of Poles	Width	Length	Depth	To Handle D1
2, 3	4.1 (105)	6.9 (175)	3.4 (81)	4.2 (107)

Shipping Weight, lbs. (kg)

Poles	Frame	Trip Unit		Complete Breaker
		Thermal-Mag.	Electronic	
2, 3	4.0 (1.8)	2.2 (1.0)	2.6 (1.2)	6.2 (2.8)

Connectors for 75°C Wire

Construction	Ampere Rating	Wire Range	No. of cables per connector	Catalog Number
Steel	50-250	#4-350 kcmil Cu	1	3TW1FG350 ^③
Aluminum ^②	50-250	#4-350 kcmil Al/Cu	1	3TAW1FG350 ^③
Copper	50-250	#4-350 kcmil Cu	1	3TCW1FG350 ^③
Distribution Lugs				
	50-250	#12-2/0 Cu	3	3TA3FG20 ^③
	50-250	#14-#4 Cu	6	3TA6FG04 ^③

^① 2-pole FG breakers are rated 600Y/347.

^② Standard connector supplied with complete breakers.

^③ Kit consists of 3 terminal connectors.

^④ 2 Lugs for 2-pole breakers.

^⑤ 3 Lugs for 3-pole breakers.

FG Thermal-Magnetic, Instantaneous Trip Adjustment Range

Trip Unit Continuous Amp Rating (I _n)	Instantaneous Overcurrent Setting (I _l)	
	Min.	Max.
100	625	1250
110	800	1600
125	800	1600
150	800	1600
175	1000	2000
200	1000	2000
225	1250	2500
250	1250	2500

Note: Each breaker has 6 trip settings in this range.

External Accessories pages 17/43 to 17/57

VL Molded Case Circuit Breakers

FG 250A Thermal-Magnetic Trip Unit

Selection

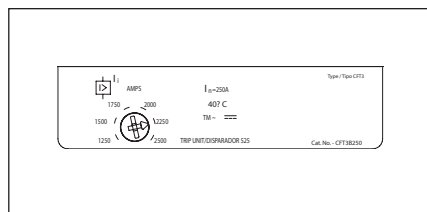

Model 525 Trip Unit

FG 250A Frame 2-Pole with Thermal-Magnetic Trip Unit

Continuous Ampere Rating	COMPLETE FACTORY ASSEMBLED CIRCUIT BREAKER		
	N-Interrupting Class	H-Interrupting Class	L-Interrupting Class
	Catalog Number	Catalog Number	Catalog Number
100	NFK2B100L	HFK2B100L	LFK2B100L
110	NFK2B110L	HFK2B110L	LFK2B110L
125	NFK2B125L	HFK2B125L	LFK2B125L
150	NFK2B150L	HFK2B150L	LFK2B150L
175	NFK2B175L	HFK2B175L	LFK2B175L
200	NFK2B200L	HFK2B200L	LFK2B200L
225	NFK2B225L	HFK2B225L	LFK2B225L
250	NFK2B250L	HFK2B250L	LFK2B250L

FG 250A Frame 3-Pole with Thermal-Magnetic Trip Unit

Continuous Ampere Rating	N-Interrupting Class	H-Interrupting Class	L-Interrupting Class	Catalog Number
	Catalog Number	Catalog Number	Catalog Number	
	FRAME ONLY			
	NFG3F250	HFG3F250	LFG3F250	
	COMPLETE FACTORY ASSEMBLED CIRCUIT BREAKER			
100	NFG3B100L	HFG3B100L	LFG3B100L	CFT3B100
110	NFG3B110L	HFG3B110L	LFG3B110L	CFT3B110
125	NFG3B125L	HFG3B125L	LFG3B125L	CFT3B125
150	NFG3B150L	HFG3B150L	LFG3B150L	CFT3B150
175	NFG3B175L	HFG3B175L	LFG3B175L	CFT3B175
200	NFG3B200L	HFG3B200L	LFG3B200L	CFT3B200
225	NFG3B225L	HFG3B225L	LFG3B225L	CFT3B225
250	NFG3B250L	HFG3B250L	LFG3B250L	CFT3B250

VL Molded Case Circuit Breakers

FG 250A Electronic 3-Knob & LCD Trip Units

Selection

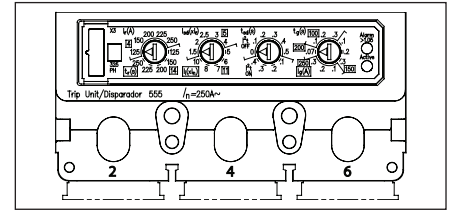
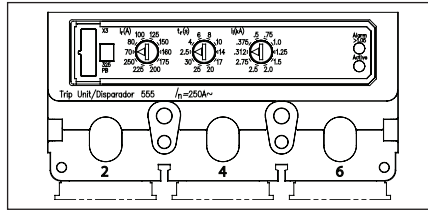

Model 555 Trip Units

FG 250A Frame 3-Pole Electronic Trip Unit^①

Continuous Ampere Rating	N-Interrupting Class	H-Interrupting Class	L-Interrupting Class	Catalog Number
	Catalog Number	Catalog Number	Catalog Number	
	FRAME ONLY			
	NFG3F250	HFG3F250	LFG3F250	
COMPLETE FACTORY ASSEMBLED CIRCUIT BREAKER				TRIP UNIT ONLY
ELECTRONIC LI TRIP				
100	NFG3R100L	HFG3R100L	LFG3R100L	CFT3R100
150	NFG3R150L	HFG3R150L	LFG3R150L	CFT3R150
250	NFG3R250L	HFG3R250L	LFG3R250L	CFT3R250
ELECTRONIC LSI TRIP				
100	NFG3T100L	HFG3T100L	LFG3T100L	CFT3T100
150	NFG3T150L	HFG3T150L	LFG3T150L	CFT3T150
250	NFG3T250L	HFG3T250L	LFG3T250L	CFT3T250
ELECTRONIC LSIG TRIP				
100	NFG3V100L	HFG3V100L	LFG3V100L	CFT3V100
150	NFG3V150L	HFG3V150L	LFG3V150L	CFT3V150
250	NFG3V250L	HFG3V250L	LFG3V250L	CFT3V250
ELECTRONIC LIG TRIP				
100	NFG3W100L	HFG3W100L	LFG3W100L	CFT3W100
150	NFG3W150L	HFG3W150L	LFG3W150L	CFT3W150
250	NFG3W250L	HFG3W250L	LFG3W250L	CFT3W250

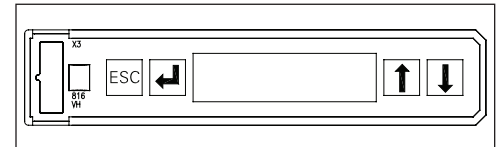

Model 586 Trip Unit

FG 250A Frame 3-Pole Electronic LCD Trip Unit^①

Continuous Ampere Rating	N-Interrupting Class	H-Interrupting Class	L-Interrupting Class	Catalog Number
	Catalog Number	Catalog Number	Catalog Number	
	FRAME ONLY			
	NFG3F250	HFG3F250	LFG3F250	
COMPLETE FACTORY ASSEMBLED CIRCUIT BREAKER				TRIP UNIT ONLY
LCD ELECTRONIC LSI TRIP				
100	NFG3A100L	HFG3A100L	LFG3A100L	CFT3A100
150	NFG3A150L	HFG3A150L	LFG3A150L	CFT3A150
250	NFG3A250L	HFG3A250L	LFG3A250L	CFT3A250
LCD ELECTRONIC LSIG TRIP				
100	NFG3G100L	HFG3G100L	LFG3G100L	CFT3G100
150	NFG3G150L	HFG3G150L	LFG3G150L	CFT3G150
250	NFG3G250L	HFG3G250L	LFG3G250L	CFT3G250
LCD ELECTRONIC LSI TRIP + GF ALARM ONLY				
100	NFG3K100L	HFG3K100L	LFG3K100L	CFT3K100
150	NFG3K150L	HFG3K150L	LFG3K150L	CFT3K150
250	NFG3K250L	HFG3K250L	LFG3K250L	CFT3K250

^① Due to the location of the magnetic tripping solenoid, the left accessory pocket is not available for accessories.

VL Molded Case Circuit Breakers

Internal Accessories for DG 150A and FG 250A Frames

Selection

Auxiliary Switch and Alarm Switch Combination Kits

Description	Mounting Pocket ^①	Catalog Number
1 Alarm Switch 1A/B ^③ Bases AMBL2 & AMBL3	Left, Right ^②	ASKL1
2 Aux. Switches 1A + 1B Bases AMBL1	Left, Right	ASKL2
2 Aux. + 1 Alarm Switches 1A + 1B, 1A/B ^③ Bases AMBL2 & AMBL3	Left, Right ^②	ASKL3

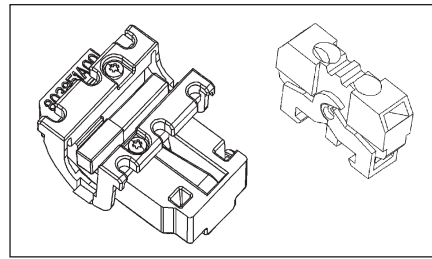

Auxiliary/Alarm Switch Mounting Base Only

Description	Mounting Pocket	Catalog Number
Up to 3 Auxiliary Switches	Left, Right	AMBL1
2 Aux. + 1 Alarm Switch	Left Pocket Only	AMBL2
2 Aux. + 1 Alarm Switch	Right Pocket Only	AMBL3

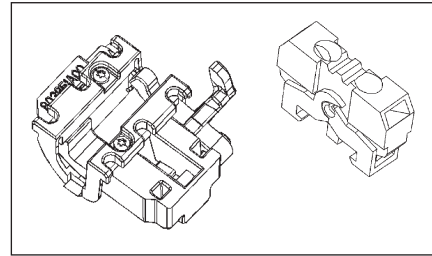

Auxiliary/Alarm Switch Only

Common to DG - PG Frames

Description	Catalog Number
1 Normally Open Contact (1A)	ASWPA
1 Normally Closed Contact (1B)	ASWPB

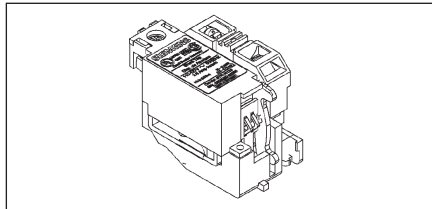

Shunt Trips

Description	Mounting Pocket	Catalog Number
24 VDC	Right Pocket Only	STRLB24DC
48-60 VDC		STRLC60DC
110-127 VDC		STRLD125DC
220-250 VDC		STRLE250DC
48-60 VAC		STRLM60
110-127 VAC		STRLN120
208-277 VAC		STRLS277
380-600 VAC		STRLV600

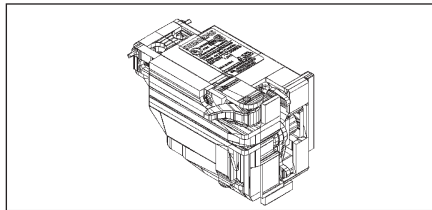

Undervoltage Release

Description	Mounting Pocket	Catalog Number
12 VDC	Right Pocket Only	UVRLA12DC
24 VDC		UVRLB24DC
48 VDC		UVRLC48DC
60 VDC		UVRLG60DC
110-127 VDC		UVRLD125DC
220-250 VDC		UVRLE250DC
24 VAC		UVRL24
110-127 VAC		UVRLN120
220-240 VAC		UVRLR240
208 VAC		UVRLP208
277 VAC		UVRLS277
380-415 VAC		UVRLT415
440-480 VAC		UVRLU480

① Refer to the "Accessory Locations" chart on page 17/58 for guidelines and limitations about which pockets may be used for accessory combinations.

② These kits include two bases, one for mounting switches in the left pocket and another for mounting in the right.

③ Includes 1A and 1B contact for alarm purposes, only one of which may be installed at any time.

'A' refers to a normally open contact (open when the breaker contacts are open).

'B' refers to a normally closed contact (closed when the breaker contacts are open).

External Accessories pages 17/43 through 17/57

VL Molded Case Circuit Breakers

JG 400A Frame, VL Series

Selection/Dimensions

Ordering Information

Complete Assembled Breaker

A complete factory assembled JG breaker includes the frame, trip unit, and standard line and load connectors, all factory installed and shipped as a complete breaker. Assembled breakers are available only with standard connectors.

For any other configuration, order the frame, trip unit, and terminals as separate items.

For DC applications, use thermal magnetic trip unit only.

For reverse feed applications, select non-interchangeable trip breakers only.

For non-interchangeable trip breakers, change the third digit of the catalog number to "X" for standard breakers.

For 100% rated breakers with a non-interchangeable trip unit, change the 3rd character of the catalog number to "Y".

For special applications, refer to page 17/62.

Mounting hardware is included with each frame or complete breaker.

HACR rated.



Dimensions, inches (mm)

Number of Poles	Width	Length	Depth	To Handle D1
2, 3	5.5 (139)	11 (279)	4.2 (102)	5.4 (138)

Interrupting Ratings

Interrupting Class	Breaker Type	RMS Symmetrical Amperes (KA)										
		UL 489 AIR (File E10848)					IEC 60947-2					
		Volts AC (50/60 Hz)					Volts AC (50/60 Hz)					
		240	480	600	250	500	220/240		380/415		690	
					I _{cu}	I _{cs}	I _{cu}	I _{cs}	I _{cu}	I _{cs}		
N	NJGA	65	35	25	30	25	65	65	45	45	12	6
H	HJGA	100	65	25	30	35	100	75	70	70	15	8
L	LJGA	200	100	25	30	35	200	150	100	75	15	8

Shipping Weight, lbs. (kg)

Poles	Frame	Trip Unit		Complete Breaker
		Thermal-Mag.	Electronic	
2, 3	9.3 (4.2)	4.0 (1.8)	4.0 (1.8)	12.6 (5.7)

Connectors for 75°C Wire

Construction	Ampere Rating	Wire Range	No. of cables per connector	Catalog Number
Steel	70-400	1/0-600 kcmil Cu	1	3TW1JG600 ^②
Aluminum	70-400	3/0-250 kcmil Al/Cu	2	3TA2JG250 ^{①②}
Aluminum	70-400	250-750 kcmil Al	1	3TA1JG750 ^②
Aluminum	70-400	3/0-600 kcmil Cu	1	3TA1JG750 ^②
Copper	70-400	3/0-600 kcmil Cu	1	TC1JG750 ^③
Copper	70-400	3/0-250 kcmil Cu	2	TC2JG250 ^③
Distribution Lugs				
	70-400	#14-4 Cu	12	3TA12JG04 ^②
	70-400	#14-2/0 Al/Cu	6	3TA6JG20 ^②
Compression Lugs				
	70-400	#6-350 kcmil	—	3CLJ350 ^②
	70-400	250-600 kcmil	—	3CLJ600 ^②
	70-400	250-750 kcmil	—	3CLJ750 ^②

① Standard construction supplied for each breaker.

② Kit consists of 3 terminal connectors.

③ Required for 100% rated JG breakers. Requires 90°C Cu cable sized at 75°C ampacity.

JG Thermal-Magnetic, Instantaneous Trip Adjustment Range

Trip Unit Continuous Amp Rating (I _n)	Instantaneous Overcurrent Setting (I _i)	
	Min.	Max.
250	1250	2500
300	1500	3000
350	1750	3500
400	2000	4000

Note: Each breaker has 6 trip settings in this range.

External Accessories pages 17/43 through 17/57

VL Molded Case Circuit Breakers

JG 400A Thermal-Magnetic Trip Unit

Selection

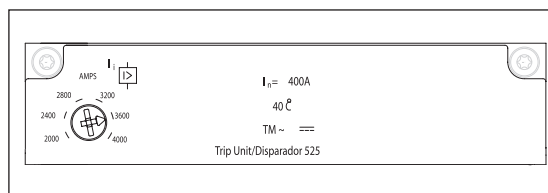

Model 525 Trip Unit

JG 400A Frame 2-Pole with Thermal-Magnetic Trip Unit

Continuous Ampere Rating	N-Interrupting Class	H-Interrupting Class	L-Interrupting Class	Catalog Number
	Catalog Number	Catalog Number	Catalog Number	
	FRAME ONLY			
	NJG2F400	HJG2F400	LJG2F400	
	COMPLETE FACTORY ASSEMBLED CIRCUIT BREAKER			TRIP UNIT ONLY
250	NJG2B250L	HJG2B250L	LJG2B250L	CJT2B250
300	NJG2B300L	HJG2B300L	LJG2B300L	CJT2B300
350	NJG2B350L	HJG2B350L	LJG2B350L	CJT2B350
400	NJG2B400L	HJG2B400L	LJG2B400L	CJT2B400

JG 400A Frame 3-Pole with Thermal-Magnetic Trip Unit

Continuous Ampere Rating	N-Interrupting Class	H-Interrupting Class	L-Interrupting Class	Catalog Number
	Catalog Number	Catalog Number	Catalog Number	
	FRAME ONLY			
	NJG3F400	HJG3F400	LJG3F400	
	COMPLETE FACTORY ASSEMBLED CIRCUIT BREAKER			TRIP UNIT ONLY
250	NJG3B250L	HJG3B250L	LJG3B250L	CJT3B250
300	NJG3B300L	HJG3B300L	LJG3B300L	CJT3B300
350	NJG3B350L	HJG3B350L	LJG3B350L	CJT3B350
400	NJG3B400L	HJG3B400L	LJG3B400L	CJT3B400

JJ 400A Frame 240V max., 2-pole with Thermal-Magnetic Non-Interchangeable Trip Unit^①

Continuous Ampere Rating	N-Interrupting Class
	Catalog Number
	COMPLETE BREAKER
250	NJJ2B250
300	NJJ2B300
350	NJJ2B350
400	NJJ2B400

JJ 400A Frame 240V max., 3-pole with Thermal-Magnetic Non-Interchangeable Trip Unit^①

Continuous Ampere Rating	N-Interrupting Class
	Catalog Number
	COMPLETE BREAKER
250	NJJ3B250
300	NJJ3B300
350	NJJ3B350
400	NJJ3B400

^① Terminal connectors must be ordered separately.
Breaker Type NJJA.

VL Molded Case Circuit Breakers

JG 400A Electronic 3-Knob & LCD Trip Units

Selection

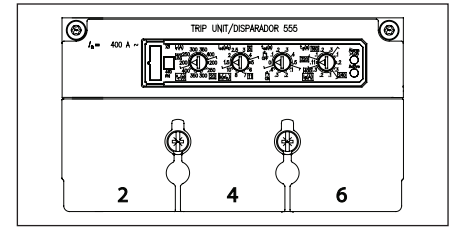
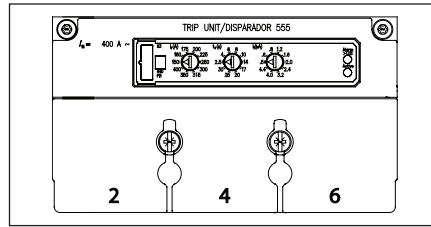

Model 555 Trip Units

JG 400A Frame 3-Pole Electronic Trip Unit

Continuous Ampere Rating	N-Interrupting Class	H-Interrupting Class	L-Interrupting Class	Catalog Number
	Catalog Number	Catalog Number	Catalog Number	
	FRAME ONLY			
	NJG3F400	HJG3F400	LJG3F400	
COMPLETE FACTORY ASSEMBLED CIRCUIT BREAKER				TRIP UNIT ONLY
ELECTRONIC LI TRIP				
250	NJG3R250L	HJG3R250L	LJG3R250L	CJT3R250
400	NJG3R400L	HJG3R400L	LJG3R400L	CJT3R400
ELECTRONIC LSI TRIP				
250	NJG3T250L	HJG3T250L	LJG3T250L	CJT3T250
400	NJG3T400L	HJG3T400L	LJG3T400L	CJT3T400
ELECTRONIC LSIG TRIP				
250	NJG3V250L	HJG3V250L	LJG3V250L	CJT3V250
400	NJG3V400L	HJG3V400L	LJG3V400L	CJT3V400
ELECTRONIC LIG TRIP				
250	NJG3W250L	HJG3W250L	LJG3W250L	CJT3W250
400	NJG3W400L	HJG3W400L	LJG3W400L	CJT3W400

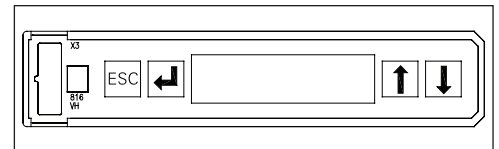

Model 586 Trip Unit

JG 400A Frame 3-Pole Electronic LCD Trip Unit

Continuous Ampere Rating	N-Interrupting Class	H-Interrupting Class	L-Interrupting Class	Catalog Number
	Catalog Number	Catalog Number	Catalog Number	
	FRAME ONLY			
	NJG3F400	HJG3F400	LJG3F400	
COMPLETE FACTORY ASSEMBLED CIRCUIT BREAKER				TRIP UNIT ONLY
LCD ELECTRONIC LSI TRIP				
250	NJG3A250L	HJG3A250L	LJG3A250L	CJT3A250
400	NJG3A400L	HJG3A400L	LJG3A400L	CJT3A400
LCD ELECTRONIC LSIG TRIP				
250	NJG3G250L	HJG3G250L	LJG3G250L	CJT3G250
400	NJG3G400L	HJG3G400L	LJG3G400L	CJT3G400
LCD ELECTRONIC LSI TRIP + GF ALARM ONLY				
250	NJG3K250L	HJG3K250L	LJG3K250L	CJT3K250
400	NJG3K400L	HJG3K400L	LJG3K400L	CJT3K400

VL Molded Case Circuit Breakers

LG 600A Frame, VL Series

Selection/Dimensions

Ordering Information

Complete Assembled Breaker

A complete factory assembled LG breaker includes the frame, trip unit, and standard line and load lugs, all factory installed and shipped as a complete breaker. Assembled breakers are available only with standard connectors.

For DC applications, use thermal magnetic trip unit only.

Breakers are suitable for reverse feed applications.

For special applications, refer to page 17/62.

Mounting hardware is included with each breaker.

For 100% rated breakers, change the 3rd character of the catalog number to "W". Available on 400/500 Amp only (3-pole only).

HACR rated.



Interrupting Ratings

Interrupting Class	Breaker Type	RMS Symmetrical Amperes (KA)										
		UL 489					IEC 60947-2					
		Volts AC (50/60 Hz)			Volts DC		Volts AC (50/60 Hz)					
		240	480	600	250	500	220/240		380/415		690	
					I _{CU}	I _{CS}	I _{CU}	I _{CS}	I _{CU}	I _{CS}		
N	NLGB	65	35	18	30	25	65	65	45	45	12	6
H	HLGB	100	65	18 ^①	30	35	100	75	70	70	15	8
L	LLGB	200	100	18	30	35	200	150	100	75	15	8

① Special 600Vac 25kA thermal-magnetic version (Type HLGC) available, see page 17/28.

Connectors for 75°C Wire

Construction	Ampere Rating	Wire Range	No. of cables per connector	Catalog Number ^③
Aluminum	150-600	#2-600 kcmil Al/Cu	2 (load side)	3TA2LG600LD ^②
Aluminum	150-600	#2-600 kcmil Al/Cu	2 (line side)	3TA2LG600LN ^②
Copper	150-600	#2-600 kcmil Cu	2 (load side)	3TC2LG600LD ^③
Copper	150-600	#2-600 kcmil Cu	2 (line side)	3TC2LG600LN ^③
Compression Lugs				
	150-600	#6-350 kcmil Al/Cu	—	6CLL350 ^④
	150-600	250-750 kcmil Al/Cu	—	3CLL750 ^③
	150-600	250-600 kcmil Al/Cu	—	6CLL600 ^⑤

② Standard construction supplied for each breaker.

③ Kit consists of 3 terminal connectors.

④ Kit consists of 6 lugs for Line or Load end.

⑤ Required for 100% rated LG breakers. Requires 90°C Cu cable sized at 75°C ampacity.

LG Thermal-Magnetic, Instantaneous Trip Adjustment Range

Trip Unit Continuous Amp Rating (I _n)	Instantaneous Overcurrent Setting (I _t)	
	Min.	Max.
400	2000	4000
500	2500	5000
600	2750	5500

Note: Each breaker has 6 trip settings.

Dimensions, inches (mm)

Number of Poles	Width	Length	Depth	To Handle D1
2, 3	5.5 (139)	11 (279)	4.2 (102)	5.4 (138)
Ext. Shield		13.6 (345.5)		

Shipping Weight, lbs. (kg)

Poles	Frame	Trip Unit		Complete Breaker
		Thermal-Mag.	Electronic	
2, 3	17.4 (7.9)	3.5 (1.6)	4.2 (1.9)	20.9 (9.5)

VL Molded Case Circuit Breakers

LG 600A Thermal-Magnetic Trip Unit

Selection

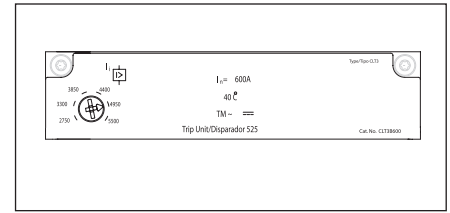

Model 525 Trip Unit

LG 600A Frame 2-Pole with Thermal-Magnetic Trip Unit

Continuous Ampere Rating	N-Interrupting Class	H-Interrupting Class	L-Interrupting Class
	Catalog Number	Catalog Number	Catalog Number
	COMPLETE FACTORY ASSEMBLED CIRCUIT BREAKER		
400	NLK2B400L	HLK2B400L	LLK2B400L
500	NLK2B500L	HLK2B500L	LLK2B500L
600	NLK2B600L	HLK2B600L	LLK2B600L

LG 600A Frame 3-Pole with Thermal-Magnetic Trip Unit^①

Continuous Ampere Rating	N-Interrupting Class	H-Interrupting Class	L-Interrupting Class
	Catalog Number	Catalog Number	Catalog Number
	COMPLETE FACTORY ASSEMBLED CIRCUIT BREAKER		
400	NLK3B400L	HLK3B400L	LLK3B400L
500	NLK3B500L	HLK3B500L	LLK3B500L
600	NLK3B600L	HLK3B600L	LLK3B600L

LG 600A Frame 2-Pole with Thermal-Magnetic Trip Unit , 600Vac 25kA only^②

Continuous Ampere Rating	N-Interrupting Class	H-Interrupting Class	L-Interrupting Class
	Catalog Number	Catalog Number	Catalog Number
	COMPLETE FACTORY ASSEMBLED CIRCUIT BREAKER		
400	—	HLV2B400L	—
500	—	HLV2B500L	—
600	—	HLV2B600L	—

LG 600A Frame 3-Pole with Thermal-Magnetic Trip Unit , 600Vac 25kA only^{①②}

Continuous Ampere Rating	N-Interrupting Class	H-Interrupting Class	L-Interrupting Class
	Catalog Number	Catalog Number	Catalog Number
	COMPLETE FACTORY ASSEMBLED CIRCUIT BREAKER		
400	—	HLV3B400L	—
500	—	HLV3B500L	—
600	—	HLV3B600L	—

① For 100% rated 400A or 500A versions, change the third character of the catalog number to "Z".

② Consult sales office for availability.

VL Circuit Breakers

LG 600A Electronic Trip Units

Selection

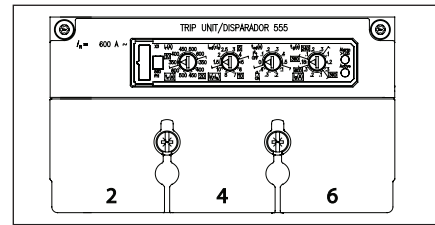
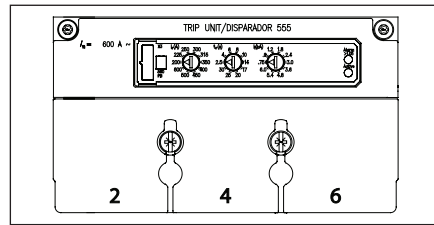

Model 555 Trip Unit

LG 600A Frame 3-Pole Electronic Trip Unit

Continuous Ampere Rating	N-Interrupting Class	H-Interrupting Class	L-Interrupting Class
	Catalog Number	Catalog Number	Catalog Number
COMPLETE FACTORY ASSEMBLED CIRCUIT BREAKER			
ELECTRONIC LI TRIP			
400	NLK3R400L	HLK3R400L	LLK3R400L
600	NLK3R600L	HLK3R600L	LLK3R600L
ELECTRONIC LSI TRIP			
400	NLK3T400L	HLK3T400L	LLK3T400L
600	NLK3T600L	HLK3T600L	LLK3T600L
ELECTRONIC LSIG TRIP			
400	NLK3V400L	HLK3V400L	LLK3V400L
600	NLK3V600L	HLK3V600L	LLK3V600L
ELECTRONIC LIG TRIP			
400	NLK3W400L	HLK3W400L	LLK3W400L
600	NLK3W600L	HLK3W600L	LLK3W600L

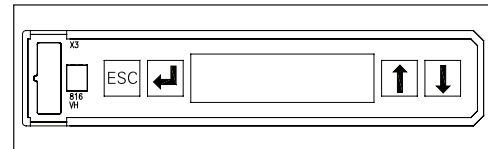

Model 586 Trip Unit

LG 600A Frame 3-Pole Electronic LCD Trip Unit

Continuous Ampere Rating	N-Interrupting Class	H-Interrupting Class	L-Interrupting Class
	Catalog Number	Catalog Number	Catalog Number
COMPLETE FACTORY ASSEMBLED CIRCUIT BREAKER			
ELECTRONIC LSI TRIP			
400	NLK3A400L	HLK3A400L	LLK3A400L
600	NLK3A600L	HLK3A600L	LLK3A600L
ELECTRONIC LSIG TRIP			
400	NLK3G400L	HLK3G400L	LLK3G400L
600	NLK3G600L	HLK3G600L	LLK3G600L
ELECTRONIC LSI TRIP + GF ALARM ONLY			
400	NLK3K400L	HLK3K400L	LLK3K400L
600	NLK3K600L	HLK3K600L	LLK3K600L

VL Molded Case Circuit Breakers

Internal Accessories for JG 400A and LG 600A Frames

Selection

Auxiliary Switch and Alarm Switch Combination Kits

Description	Mounting Pocket ^①	Catalog Number
1 Alarm Switch 1A/B ^③ Bases AMBL2 & AMBL3	Left, Right ^②	ASKL1
2 Aux. Switches 1A + 1B Bases AMBL1	Left, Right	ASKL2
2 Aux. + 1 Alarm Switches 1A + 1B, 1A/B ^③ Bases AMBL2 & AMBL3	Left, Right ^②	ASKL3

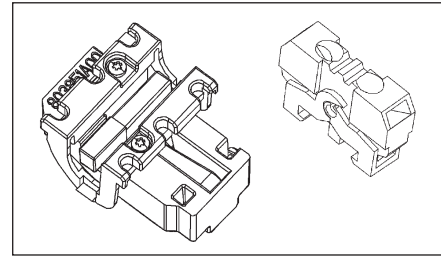

Auxiliary/Alarm Switch Mounting Base Only

Description	Mounting Pocket	Catalog Number
Up to 3 Auxiliary Switches	Left, Right	AMBL1
2 Aux. + 1 Alarm Switch	Left Pocket Only	AMBL2
2 Aux. + 1 Alarm Switch	Right Pocket Only	AMBL3

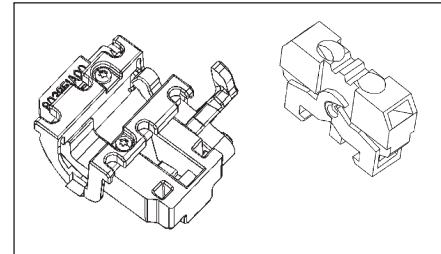

Auxiliary/Alarm Switch Only

Common to DG - PG Frames

Description	Catalog Number
1 Normally Open Contact (1A)	ASWPA
1 Normally Closed Contact (1B)	ASWPB

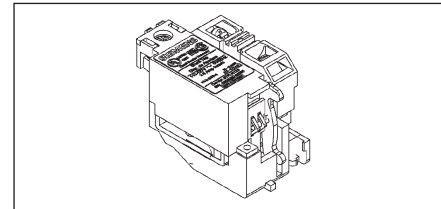

Shunt Trips

Description	Mounting Pocket	Catalog Number
24 VDC	Right Pocket Only	STRLB24DC
48-60 VDC		STRLC60DC
110-127 VDC		STRLD125DC
220-250 VDC		STRLE250DC
48-60 VAC		STRLM60
110-127 VAC		STRLN120
208-277 VAC		STRLS277
380-600 VAC		STRLV600

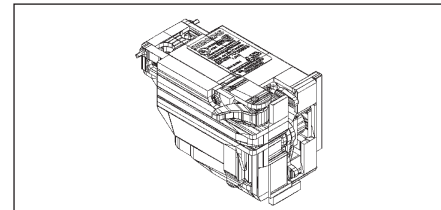

Undervoltage Release

Description	Mounting Pocket	Catalog Number
12 VDC	Right Pocket Only	UVRLA12DC
24 VDC		UVRLB24DC
48 VDC		UVRLC48DC
60 VDC		UVRLG60DC
110-127 VDC		UVRLD125DC
220-250 VDC		UVRLE250DC
24 VAC		UVRLI24
110-127 VAC		UVRLN120
220-240 VAC		UVRLR240
208 VAC		UVRLP208
277 VAC		UVRLS277
380-415 VAC		UVRLT415
440-480 VAC		UVRLU480

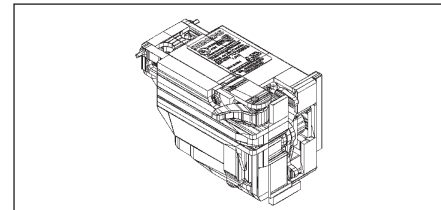

^① Refer to the "Accessory Locations" chart on page 17/58 for guidelines and limitations about which pockets may be used for accessory combinations.

^② Includes 1A and 1B contact for alarm purposes, only one of which may be installed at any time.

'A' refers to a normally open contact (open when the breaker contacts are open).

'B' refers to a normally closed contact (closed when the breaker contacts are open).

VL Molded Case Circuit Breakers

MG 800A Frame, VL Series

Selection/Dimensions

Ordering Information

Complete Assembled Breaker

A complete factory assembled MG breaker includes the frame, trip unit, and standard line and load lugs, all factory installed and shipped as a complete breaker. Assembled breakers are available only with standard connectors.

For any other configuration, order the frame, trip unit, and terminals as separate items.

For DC applications, use thermal magnetic trip unit only.

For reverse feed applications, select non-interchangeable trip breakers only. For non-interchangeable trip breakers, change the third digit of the catalog number to "X" for standard breakers.

For 100% rated breakers with a non-interchangeable trip unit, change the 3rd character of the catalog number to "Y".

For special applications, refer to page 17/62.

Mounting hardware is included with each frame or complete breaker.

HACR rated.



Dimensions, inches (mm)

Number of Poles	Width	Length	Depth	To Handle D1
2, 3	7.5 (190)	16 (406)	4.7 (119)	5.9 (151)

Interrupting Ratings

Interrupting Class	Breaker Type	RMS Symmetrical Amperes (KA)										
		UL 489					IEC 60947-2					
		Volts AC (50/60 Hz)			Volts DC		Volts AC (50/60 Hz)					
		240	480	600	250	500	220/240		380/415		690	
					I _{cu}	I _{cs}	I _{cu}	I _{cs}	I _{cu}	I _{cs}		
N	NMG	65	35	25	22	35	65	65	50	50	20	10
H	HMG	100	65	35	25	50	100	75	70	70	30	15
L	LMG	200	100	50	42	65	200	150	100	75	35	17

Shipping Weight, lbs. (kg)

Poles	Frame	Trip Unit	Complete Breaker
2, 3	31.3 (14.2)	4.0 (1.8)	35.3 (16.0)

Connectors for 75°C Wire

Construction	Ampere Rating	Wire Range	No. of cables per connector	Catalog Number
Aluminum	200-800A	1/0-500 kcmil Al/Cu	3	3TA3MG500 ^{①②}
Aluminum	200-800A	500-750 kcmil Al/Cu	2	3TA2MG750 ^②
Copper	200-800A	1/0-500 kcmil Cu	3	TC3MG500 ^{③⑤}
Aluminum	200-800A	#2-600 kcmil Al/Cu	3	3TA3MG600 ^{②④}

① Standard connector supplied with complete breakers.

② Kit consists of 3 terminal connectors.

③ Consists of one terminal.

④ Includes extended terminal cover.

⑤ Required for 100% rated MG breakers. Requires 90°C Cu cable sized at 75°C ampacity.

MG Thermal-Magnetic, Instantaneous Trip Adjustment Range

Trip Unit Continuous Amp Rating (I _n)	Instantaneous Overcurrent Setting (I _i)	
	Min.	Max.
600	3000	6000
700	3250	6500
800	3250	6500

Note: Each breaker has 6 trip settings.

External Accessories pages 17/43 through 17/57

VL Molded Case Circuit Breakers

MG 800A Thermal-Magnetic Trip Unit

Selection

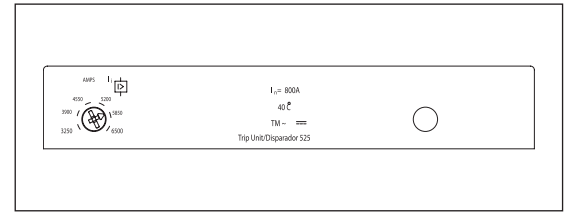

Model 525 Trip Unit

MG 800A Frame 2-Pole with Thermal-Magnetic Trip Unit

Continuous Ampere Rating	N-Interrupting Class	H-Interrupting Class	L-Interrupting Class	Catalog Number
	Catalog Number	Catalog Number	Catalog Number	
	FRAME ONLY			
	NMG2F800	HMG2F800	LMG2F800	
	COMPLETE FACTORY ASSEMBLED CIRCUIT BREAKER			
600	NMG2B600L	HMG2B600L	LMG2B600L	CMT2B600
700	NMG2B700L	HMG2B700L	LMG2B700L	CMT2B700
800	NMG2B800L	HMG2B800L	LMG2B800L	CMT2B800

MG 800A Frame 3-Pole with Thermal-Magnetic Trip Unit

Continuous Ampere Rating	N-Interrupting Class	H-Interrupting Class	L-Interrupting Class	Catalog Number
	Catalog Number	Catalog Number	Catalog Number	
	FRAME ONLY			
	NMG3F800	HMG3F800	LMG3F800	
	COMPLETE FACTORY ASSEMBLED CIRCUIT BREAKER			
600	NMG3B600L	HMG3B600L	LMG3B600L	CMT3B600
700	NMG3B700L	HMG3B700L	LMG3B700L	CMT3B700
800	NMG3B800L	HMG3B800L	LMG3B800L	CMT3B800

VL Molded Case Circuit Breakers

MG 800A Electronic 3-Knob & LCD Trip Units

Selection

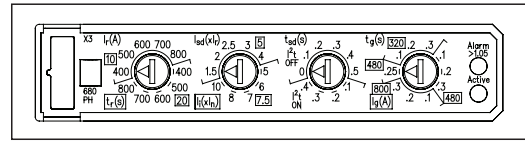
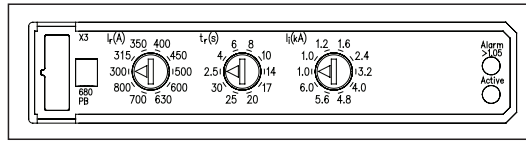

Model 555 Trip Units

MG 800A Frame 3-Pole Electronic Trip Unit

Continuous Ampere Rating	N-Interrupting Class	H-Interrupting Class	L-Interrupting Class	
	Catalog Number	Catalog Number	Catalog Number	Catalog Number
	FRAME ONLY			TRIP UNIT ONLY
	NMG3F800	HMG3F800	LMG3F800	
COMPLETE FACTORY ASSEMBLED CIRCUIT BREAKER				
ELECTRONIC LI TRIP				
600 800	NMG3R600L NMG3R800L	HMG3R600L HMG3R800L	LMG3R600L LMG3R800L	CMT3R600 CMT3R800
ELECTRONIC LSI TRIP				
600 800	NMG3T600L NMG3T800L	HMG3T600L HMG3T800L	LMG3T600L LMG3T800L	CMT3T600 CMT3T800
ELECTRONIC LSIG TRIP				
600 800	NMG3V600L NMG3V800L	HMG3V600L HMG3V800L	LMG3V600L LMG3V800L	CMT3V600 CMT3V800
ELECTRONIC LIG TRIP				
600 800	NMG3W600L NMG3W800L	HMG3W600L HMG3W800L	LMG3W600L LMG3W800L	CMT3W600 CMT3W800

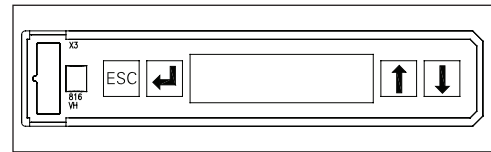

Model 586 Trip Unit

MG 800A Frame 3-Pole Electronic LCD Trip Unit

Continuous Ampere Rating	N-Interrupting Class	H-Interrupting Class	L-Interrupting Class	
	Catalog Number	Catalog Number	Catalog Number	Catalog Number
	FRAME ONLY			TRIP UNIT ONLY
	NMG3F800	HMG3F800	LMG3F800	
COMPLETE FACTORY ASSEMBLED CIRCUIT BREAKER				
LCD ELECTRONIC LSI TRIP				
600 800	NMG3A600L NMG3A800L	HMG3A600L HMG3A800L	LMG3A600L LMG3A800L	CMT3A600 CMT3A800
LCD ELECTRONIC LSIG TRIP				
600 800	NMG3G600L NMG3G800L	HMG3G600L HMG3G800L	LMG3G600L LMG3G800L	CMT3G600 CMT3G800
LCD ELECTRONIC LSI TRIP + GF ALARM ONLY				
600 800	NMG3K600L NMG3K800L	HMG3K600L HMG3K800L	LMG3K600L LMG3K800L	CMT3K600 CMT3K800

VL Molded Case Circuit Breakers

NG 1200A Frame, VL Series

Selection/Dimensions

Ordering Information

Complete Assembled Breaker with Lugs

A complete factory assembled NG breaker includes the frame, trip unit, and standard line and load lugs, all factory installed and shipped as a complete breaker. Assembled breakers are available only with standard connectors.

For any other configuration, order the frame, trip unit, and terminals as separate items.

For DC applications, use thermal magnetic trip unit only.

For reverse feed applications, select non-interchangeable trip breakers only. For non-interchangeable trip breakers, change the third digit of the catalog number to "X" for standard breakers.

For 100% rated breakers with a non-interchangeable trip unit, change the 3rd character of the catalog number to "Y".

For special applications, refer to page 17/62.

Mounting hardware is included with each frame or complete breaker.

A Toggle Handle Extension is included with each frame or complete breaker.

HACR rated.



Dimensions, inches (mm)

Number of Poles	W	L	D	To Handle D1
2, 3	9 (229)	16 (406)	6 (152)	8.1 (207)

Interrupting Ratings

Interrupting Class	Breaker Type	RMS Symmetrical Amperes (KA)										
		UL 489					IEC 60947-2					
		Volts AC (50/60 Hz)			Volts DC		Volts AC (50/60 Hz)					
		240	480	600	250	500	220/240		380/415		690	
					I _{cu}	I _{cs}	I _{cu}	I _{cs}	I _{cu}	I _{cs}		
N	NNG	65	35	25	22	35	65	35	50	25	20	10
H	HNG	100	65	35	25	50	100	50	70	35	30	15
L	LNG	200	100	65	42	65	200	100	100	50	35	17

Shipping Weight, lbs. (kg)

Poles	Frame	Trip Unit	Complete Breaker
2, 3	46.3 (21.0)	8.8 (4.0)	55.1 (25.0)

Connectors for 75°C Wire

Construction	Ampere Rating	Wire Range	No. of cables per connector	Catalog Number
Aluminum	300-1200A	1/0-500 kcmil Al/Cu	4	3TA4NG500 ^{③④}
Aluminum	300-1200A	500-750 kcmil Al/Cu	3	3TA3NG750 ^④
Copper	300-1200A	1/0-500 kcmil Cu	4	3TC4NG500 ^{②④}
Aluminum	300-1200A	1/0-500 kcmil Al/Cu	4	3TA4NG500H ^{②④}
Compression Lugs				
	300-1200A	1/0-500 kcmil Al/Cu	—	12CLN500 ^①

① Total of 12 connectors (4 per phase Line or Load).

② For 100% rated NG breakers. Requires 90°C Cu cable sized at 75°C ampacity.

③ Standard connector provided with complete breakers.

④ Kit consists of 3 terminal connectors.

NG Thermal-Magnetic, Instantaneous Trip Adjustment Range

Trip Unit Continuous Amp Rating (I _n)	Instantaneous Overcurrent Setting (I _t)	
	Min.	Max.
800	4000	8000
900	5000	10000
1000	5000	10000
1200	7000	12000

Note: Each breaker has 6 trip settings.

External Accessories pages 17/43 through 17/57

VL Molded Case Circuit Breakers

NG 1200A Thermal-Magnetic Trip Unit

Selection

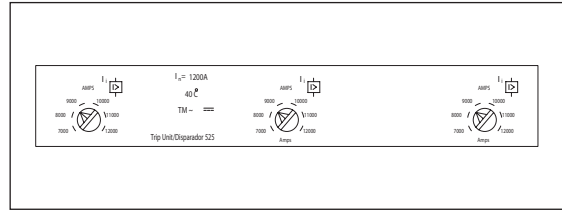

Model 525 Trip Unit

NG 1200A Frame 2-Pole with Thermal-Magnetic Trip Unit

Continuous Ampere Rating	N-Interrupting Class	H-Interrupting Class	L-Interrupting Class	
	Catalog Number	Catalog Number	Catalog Number	Catalog Number
	FRAME ONLY			TRIP UNIT ONLY
	NNG2F120	HNG2F120	LNG2F120	
	COMPLETE FACTORY ASSEMBLED CIRCUIT BREAKER			
800	NNG2B800L	HNG2B800L	LNG2B800L	CNT2B800
900	NNG2B900L	HNG2B900L	LNG2B900L	CNT2B900
1000	NNG2B100L	HNG2B100L	LNG2B100L	CNT2B100
1200	NNG2B120L	HNG2B120L	LNG2B120L	CNT2B120

NG 1200A Frame 3-Pole with Thermal-Magnetic Trip Unit

Continuous Ampere Rating	N-Interrupting Class	H-Interrupting Class	L-Interrupting Class	
	Catalog Number	Catalog Number	Catalog Number	Catalog Number
	FRAME ONLY			TRIP UNIT ONLY
	NNG3F120	HNG3F120	LNG3F120	
	COMPLETE FACTORY ASSEMBLED CIRCUIT BREAKER			
800	NNG3B800L	HNG3B800L	LNG3B800L	CNT3B800
900	NNG3B900L	HNG3B900L	LNG3B900L	CNT3B900
1000	NNG3B100L	HNG3B100L	LNG3B100L	CNT3B100
1200	NNG3B120L	HNG3B120L	LNG3B120L	CNT3B120

VL Molded Case Circuit Breakers

NG 1200A Electronic Trip Units

Selection

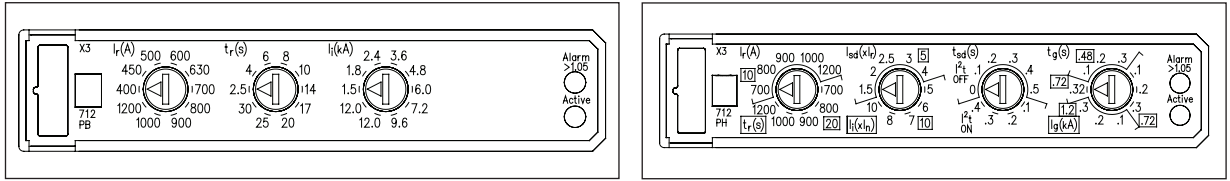

Model 555 Trip Units

NG 1200A Frame 3-Pole Electronic Trip Unit

Continuous Ampere Rating	N-Interrupting Class	H-Interrupting Class	L-Interrupting Class	Catalog Number
	Catalog Number	Catalog Number	Catalog Number	
	FRAME ONLY			
	NNG3F120	HNG3F120	LNG3F120	
COMPLETE FACTORY ASSEMBLED CIRCUIT BREAKER				TRIP UNIT ONLY
ELECTRONIC LI TRIP				
800	NNG3R800L	HNG3R800L	LNG3R800L	CNT3R800
1000	NNG3R100L	HNG3R100L	LNG3R100L	CNT3R100
1200	NNG3R120L	HNG3R120L	LNG3R120L	CNT3R120
ELECTRONIC LSI TRIP				
800	NNG3T800L	HNG3T800L	LNG3T800L	CNT3T800
1000	NNG3T100L	HNG3T100L	LNG3T100L	CNT3T100
1200	NNG3T120L	HNG3T120L	LNG3T120L	CNT3T120
ELECTRONIC LSIG TRIP				
800	NNG3V800L	HNG3V800L	LNG3V800L	CNT3V800
1000	NNG3V100L	HNG3V100L	LNG3V100L	CNT3V100
1200	NNG3V120L	HNG3V120L	LNG3V120L	CNT3V120
ELECTRONIC LIG TRIP				
800	NNG3W800L	HNG3W800L	LNG3W800L	CNT3W800
1000	NNG3W100L	HNG3W100L	LNG3W100L	CNT3W100
1200	NNG3W120L	HNG3W120L	LNG3W120L	CNT3W120

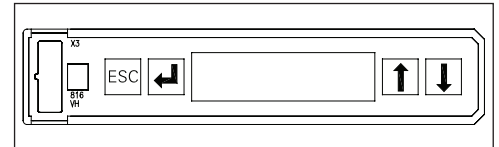

Model 586 Trip Unit

NG 1200A Frame 3-Pole Electronic LCD Trip Unit

Continuous Ampere Rating	N-Interrupting Class	H-Interrupting Class	L-Interrupting Class	Catalog Number
	Catalog Number	Catalog Number	Catalog Number	
	FRAME ONLY			
	NNG3F120	HNG3F120	LNG3F120	
COMPLETE FACTORY ASSEMBLED CIRCUIT BREAKER				TRIP UNIT ONLY
LCD ELECTRONIC LSI TRIP				
800	NNG3A800L	HNG3A800L	LNG3A800L	CNT3A800
1000	NNG3A100L	HNG3A100L	LNG3A100L	CNT3A100
1200	NNG3A120L	HNG3A120L	LNG3A120L	CNT3A120
LCD ELECTRONIC LSIG TRIP				
800	NNG3G800L	HNG3G800L	LNG3G800L	CNT3G800
1000	NNG3G100L	HNG3G100L	LNG3G100L	CNT3G100
1200	NNG3G120L	HNG3G120L	LNG3G120L	CNT3G120
LCD ELECTRONIC LSI TRIP + GF ALARM ONLY				
800	NNG3K800L	HNG3K800L	LNG3K800L	CNT3K800
1000	NNG3K100L	HNG3K100L	LNG3K100L	CNT3K100
1200	NNG3K120L	HNG3K120L	LNG3K120L	CNT3K120

VL Molded Case Circuit Breakers

PG 1600A Frame, VL Series & Thermal-Magnetic Trip Unit

Selection/Dimensions

Ordering Information

A complete factory assembled PG breaker includes the frame and trip unit only. The connectors must be ordered as separate items.

PG thermal-magnetic breakers sold as non-interchangeable only.

For any other configuration, order the frame, trip unit, and connectors as separate items.

Connectors require a Breaker Lug Mounting Assembly or Breaker Mounting Base and must be ordered as a separate item.

For DC applications, use Thermal magnetic trip unit only.

For reverse feed applications select non-interchangeable trip breakers only. Change the third digit of the catalog number to "X" for non-interchangeable trip breakers.

For 100% rated breakers with a non-interchangeable trip unit, change the 3rd character of the catalog number to "Y".

For special applications, refer to page 17/62.

Mounting hardware is included with each frame or complete breaker.

A Toggle Handle Extension is included with each frame or complete breaker.



Dimensions, inches (mm)

Number of Poles	W	L	D	To Handle D1
2, 3	9 (229)	16 (406)	6 (152)	8.1 (207)

Interrupting Ratings

Interrupting Class	Breaker Type	RMS Symmetrical Amperes (KA)										
		UL 489					IEC 60947-2					
		Volts AC (50/60 Hz)			Volts DC		Volts AC (50/60 Hz)					
		240	480	600	250	500	220/240		380/415		690	
					I _{cu}	I _{cs}	I _{cu}	I _{cs}	I _{cu}	I _{cs}		
N	NPG	65	35	25	22	35	65	35	50	25	20	10
H	HPG	100	65	35	25	50	100	50	70	35	30	15
L	LPG	200	100	65	42	65	200	100	100	50	35	17

Shipping Weight, lbs. (kg)

Poles	Frame	Trip Unit	Complete Breaker
2, 3	60.2 (27.3)	8.8 (4.0)	69.0 (31.3)

Connectors for 75°C Wire

Construction	Ampere Rating	Wire Range	No. of cables per phase	Catalog Number
Aluminum	1200-1600A	1/0-750 kcmil Al/Cu	6	3TA6PG750 ^{①③}
Aluminum	1200-1600A	300-600 kcmil Al/Cu	5	TA5P600 ^{②④}
Aluminum	1200-1600A	600-750 kcmil Al/Cu	4	TA4P750 ^{②④}
Aluminum	1200-1600A	300-600 kcmil Al/Cu	6	TA6R600 ^{②④}
Copper	1200-1600A	300-600 kcmil Cu	5	TC5R600 ^{②④⑤}

① Requires Lug Mounting Assembly LMAP1600.

② Requires Breaker Mounting Base MBPG1600 Kit or MBPG1601.

③ Consists of 3 connectors.

④ Consists of 1 connector.

⑤ Required for 100% rated PG breakers. Requires 90°C cable sized at 75°C ampacity.

PG Thermal-Magnetic, Instantaneous Trip Adjustment Range

Trip Unit Continuous Amp Rating (I _n)	Instantaneous Overcurrent Setting (I _i)	
	Min.	Max.
1200	7000	12000
1400	7000	12000
1600	7000	12000

Note: Each breaker has 6 trip settings in this range.

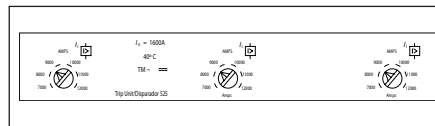

Model 525 Trip Unit

Mounting Arrangement

Description	Catalog Number
Lug Mounting Assembly	LMAP1600
Breaker Mounting Base (Front Connect)	MBPG1600
Breaker Mounting Base (Rear Connect)	MBPG1601

PG 1600A Frame 3-Pole with Thermal-Magnetic Trip Unit

Continuous Ampere Rating	N-Interrupting Class	H-Interrupting Class	L-Interrupting Class
	Catalog Number	Catalog Number	Catalog Number
	COMPLETE FACTORY ASSEMBLED CIRCUIT BREAKER		
1200	NPX3B120	HPX3B120	LPX3B120
1400	NPX3B140	HPX3B140	LPX3B140
1600	NPX3B160	HPX3B160	LPX3B160

External Accessories pages 17/43 through 17/57

VL Molded Case Circuit Breakers

PG 1600A Electronic Trip Units

Selection

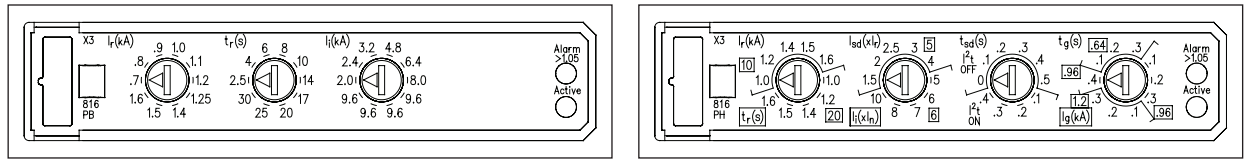

Model 555 Trip Unit

PG 1600A Frame 3-Pole Electronic Trip Unit

Continuous Ampere Rating	N-Interrupting Class	H-Interrupting Class	L-Interrupting Class	Catalog Number
	Catalog Number	Catalog Number	Catalog Number	
	FRAME ONLY			
	NPG3F160	HPG3F160	LPG3F160	
COMPLETE FACTORY ASSEMBLED CIRCUIT BREAKER				TRIP UNIT ONLY
ELECTRONIC LI TRIP				
1200	NPG3R120	HPG3R120	LPG3R120	CPT3R120
1600	NPG3R160	HPG3R160	LPG3R160	CPT3R160
ELECTRONIC LSI TRIP				
1200	NPG3T120	HPG3T120	LPG3T120	CPT3T120
1600	NPG3T160	HPG3T160	LPG3T160	CPT3T160
ELECTRONIC LSIG TRIP				
1200	NPG3V120	HPG3V120	LPG3V120	CPT3V120
1600	NPG3V160	HPG3V160	LPG3V160	CPT3V160
ELECTRONIC LIG TRIP				
1200	NPG3W120	HPG3W120	LPG3W120	CPT3W120
1600	NPG3W160	HPG3W160	LPG3W160	CPT3W160

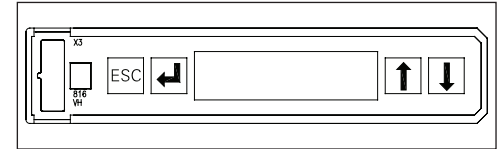

Model 586 Trip Unit

PG 1600A Frame 3-Pole Electronic LCD Trip Unit

Continuous Ampere Rating	N-Interrupting Class	H-Interrupting Class	L-Interrupting Class	Catalog Number
	Catalog Number	Catalog Number	Catalog Number	
	FRAME ONLY			
	NPG3F160	HPG3F160	LPG3F160	
COMPLETE FACTORY ASSEMBLED CIRCUIT BREAKER				TRIP UNIT ONLY
LCD ELECTRONIC LSI TRIP				
1200	NPG3A120	HPG3A120	LPG3A120	CPT3A120
1600	NPG3A160	HPG3A160	LPG3A160	CPT3A160
LCD ELECTRONIC LSIG TRIP				
1200	NPG3G120	HPG3G120	LPG3G120	CPT3G120
1600	NPG3G160	HPG3G160	LPG3G160	CPT3G160
LCD ELECTRONIC LSI TRIP + GF ALARM ONLY				
1200	NPG3K120	HPG3K120	LPG3K120	CPT3K120
1600	NPG3K160	HPG3K160	LPG3K160	CPT3K160

VL Molded Case Circuit Breakers

Internal Accessories for MG 800A, NG 1200A, and PG 1600A Frames

Selection

Auxiliary Switch and Alarm Switch Combination Kits

Description	Mounting Pocket ^①	Catalog Number
2 Aux. + 2 Alarm Switches 2A + 2B Base AMBP2	Left Pocket Only	ASKP3
4 Aux. Switches 2A + 2B Base AMBP1	Left, Right	ASKP4

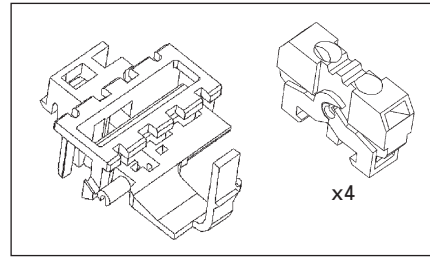

Auxiliary/Alarm Switch Mounting Base Only

Description	Mounting Pocket ^①	Catalog Number
Up to 4 Auxiliary Switches	Left, Right	AMBP1
2 Aux. + 2 Alarm Switches	Left Pocket Only	AMBP2

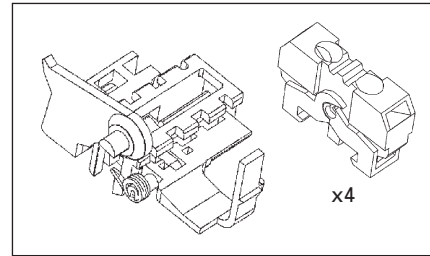

Auxiliary/Alarm Switch Only

Common to DG-PG Frames

Description	Catalog Number
1 Normally Open Contact (1A)	ASWPA
1 Normally Closed Contact (1B)	ASWPB

Shunt Trips

Description	Mounting Pocket	Catalog Number
24 VDC	Right Pocket Only	STRPB24DC
48-60 VDC		STRPC60DC
110-127 VDC		STRPD125DC
220-250 VDC		STRPE250DC
48-60 VAC		STRPM60
110-127 VAC		STRPN120
208-277 VAC		STRPS277
380-600 VAC		STRPV600

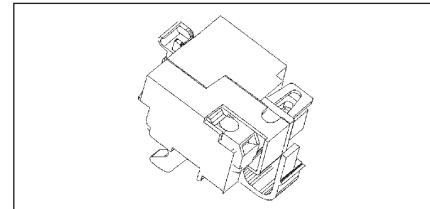

Undervoltage Release

Description	Mounting Pocket	Catalog Number
12 VDC	Right Pocket Only	UVRPA12DC
24 VDC		UVRPB24DC
48 VDC		UVRPC48DC
60 VDC		UVRPG60DC
110-127 VDC		UVRPD125DC
220-250 VDC		UVRPE250DC
110-127 VAC		UVRPN120
220-240 VAC		UVRPR240
208 VAC		UVRPP208
277 VAC		UVRPS277
380-415 VAC		UVRPT415
440-480 VAC		UVRPU480

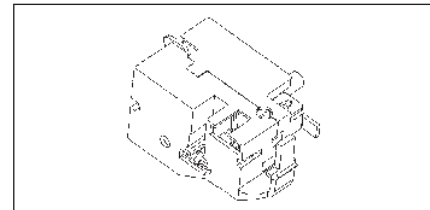

① Refer to the "Accessory Locations" chart on page 17/58 for guidelines and limitations about which pockets may be used for accessory combinations.
 'A' refers to a normally open contact (open when the breaker contacts are open).
 'B' refers to a normally closed contact (closed when the breaker contacts are open).

VL Molded Case Circuit Breakers

Molded Case Switch

Selection

General

Typically a molded case switch is used when a compact load-break switch is needed for disconnect purposes. The VL line of molded case switches from Siemens is made of the same materials and components as the VL circuit breakers but do not provide overcurrent protection. Each molded case

switch has a fixed instantaneous self-protecting trip element which may open the switch under high fault conditions.

Application Note

Overcurrent protection must be provided by an appropriate overcurrent protective device located upstream from

the molded case switch. Also, the short-circuit current rating of the switch is limited to the interrupting rating of the upstream protective device or the ratings in the table below, **whichever is less.**

Ordering Information

Each type VL molded case switch accepts the same terminals and accessories as the equivalent VL circuit breakers.

All type VL molded case switches are suitable for reverse feed applications.

Mounting hardware and standard line and load terminals are included on ratings through 250A. For 400 – 1600A ratings, order the lugs separately.

All ratings are UL listed and CSA certified.

Molded Case Switch

Maximum Ampere Rating / Frame	2-Pole	3-Pole	Short-Circuit Current Rating ^①			Self Protective Instantaneous Override
	Catalog Number	Catalog Number	240V	480V	600V	
150A / DG	HDR2S150L	HDR3S150L	100k	65k	20k	2,500A
250A / FG	HFS2S250L	HFS3S250L	100k	65k	20k	3,500A
400A / JG	HJS2S400	HJS3S400	100k	65k	25k	4,400A
600A / LG	HLR2S600	HLR3S600	100k	65k	18k	5,500A
800A / MG	HMS2S800	HMS3S800	100k	65k	35k	6,500A
1200A / NG	HNS2S120	HNS3S120	100k	65k	35k	12,000A
1600A / PG	—	HPS3S160	100k	65k	35k	14,000A

Maximum Ampere Rating / Frame	3-Pole	Short-Circuit Current Rating ^①			Self Protective Instantaneous Override
	Catalog Number	240V	480V	600V	
250A / FG	LFS3S250L	200k	100k	25k	3,500A
400A / JG	LJS3S400	200k	100k	25k	4,400A
600A / LG	LLR3S600	200k	100k	18k	5,500A
800A / MG	LMS3S800	200k	100k	65k	6,500A
1200A / NG	LNS3S120	200k	100k	65k	12,000A
1600A / PG	LPS3S160	200k	100k	65k	14,000A

^①The Short-Circuit Current Rating is the maximum available current of the circuit where the switch is used, when protected by an appropriate overcurrent protective device.

VL Molded Case Circuit Breakers

Motor Circuit Protectors

Selection

General

Protection of Motor Circuits

Molded case circuit breakers are used in motor circuits as a disconnecting means and for short-circuit protection. They should be used in conjunction with motor-running, over-current protection devices, and should permit the motor to start without nuisance tripping from motor-inrush current. The circuit breaker should have a continuous current rating of not less than 115% of the motor full-load current.

The recommended motor circuit protectors listed have continuous-current ratings of at least 115% of motor full-load currents. The trip setting positions are approximately 11 times motor full-load current. The suggested trip settings may need to be adjusted upward to no higher than 1300% of full-load current for non-design E type motors, and no greater than 1700% of full-load current for design E motors, to allow for motor startup due to in-rush current.

Breaker Mounted Immediately Ahead of Motor Starter

Siemens motor circuit protectors are recommended for use in combination motor starters to provide selective short-circuit protection for the motor branch circuit. The adjustable instantaneous trip feature of the Siemens motor circuit protector provides for a trip setting slightly above the peak motor in-rush current. With this setting, no delay is introduced in opening the circuit when a fault occurs. This circuit breaker has no time-delay trip element. Therefore it must be used in conjunction with, and immediately ahead of, the motor-running overcurrent protection device.

Important: The information below does not apply to all motor applications: it is recommended that the user refer to the National Electrical Code (NEC) for specific needs.

Table 1 (When Breaker is Mounted Immediately Ahead of Motor Starter)

3-Phase Induction Type Motors (Siemens motor circuit protectors for branch circuit use with alternating-current combination, full voltage motor starters)

Motor Full Load Amperes	Trip Setting (A)	Catalog Number ^①
35-50	450	HDP3L150L
42-60	540	
48-70	630	
55-80	720	
62-90	810	
69-100	900	
58-83	750	HDP3M150L
69-100	900	
81-117	1050	
92-133	1200	
104-150	1350	
115-150 ^②	1500	
96-139	1250	HDP3H150L
115-150 ^②	1500	
135-150 ^②	1750	
135-150 ^②	2000	
135-150 ^②	2250	
135-150 ^②	2500	
46-67	600	HFM3L250L
55-80	720	
65-93	840	
74-107	960	
83-120	1080	
92-133	1200	
77-111	1000	HFM3M250L
92-133	1200	
108-156	1400	
123-178	1600	
138-200	1800	
154-222	2000	
135-194	1750	HFM3H250L
162-210	2100	
188-220	2450	
215-241	2800	
242-250 ^②	3150	
242-250 ^②	3500	

Motor Full Load Amperes	Trip Setting (A)	Catalog Number ^①
96-139	1250	HJM3L400
115-167	1500	
135-194	1750	
154-222	2000	
173-250	2250	
192-278	2500	
154-222	2000	HJM3M400
185-267	2400	
215-311	2800	
246-356	3200	
277-400	3600	
308-400 ^②	4000	
154-222	2000	HLM3J600
185-267	2400	
215-311	2800	
246-356	3200	
277-400	3600	
308-444	4000	
212-306	2750	HLM3Y600
254-367	3300	
296-428	3850	
338-489	4400	
381-550	4950	
423-600	5500	
250-361	3250	HMM3M800
292-422	3800	
335-483	4350	
385-556	5000	
442-638	5740	
500-722	6500	
385-556	5000	HNM3M120
462-667	6000	
538-778	7000	
615-889	8000	
692-1000	9000	
769-1111	10,000	

^① Motor circuit protectors rated 150A and 250A are supplied with line and load lugs installed. If lugs are required on 400A to 1200A motor circuit breakers, order required lugs separately.

^② These settings are provided for starting currents greater than 11X but not to exceed 17X. Full Load Amps (FLA) not to exceed ampere rating of MCP.

VL Molded Case Circuit Breakers

600 Volt DC Circuit Breakers

Selection

General

Siemens UL Listed non-interchangeable trip DC Thermal/magnetic Molded Case Circuit Breakers shown below are for use in grounded & ungrounded general DC circuits and ungrounded battery supply circuits of UPS systems. These breakers are rated at 600Vdc closed circuit and feature rated interruption levels from 42,000 to 65,000 amperes as indicated in

the table. This family of circuit breakers is rated from 50 to 1600 Amperes.

Types HDGD through HPGD circuit breakers are provided with an adjustable magnetic over-current function located on the face of the circuit breaker. Contact Siemens for specific magnetic over-current values.

To properly use these UL Listed circuit breakers at 600Vdc and the indicated

interruption level, it is necessary to connect the terminals of the 3 pole circuit breaker in a series configuration as shown in the diagram below.

Types HDGD through HPGD use the same internal and external accessories as the standard DG through PG frames and associated types. Consult the individual frame section for accessory information.

Frame	Type	Continuous Ampere Rating	Catalog Number (3-pole) ^①	Short-Circuit Current Rating 600VDC ^②
DG	HDGD	50	HDC3B050	42K
		60	HDC3B060	42K
		70	HDC3B070	42K
		80	HDC3B080	42K
		90	HDC3B090	42K
		100	HDC3B100	42K
		110	HDC3B110	42K
		125	HDC3B125	42K
		150	HDC3B150	42K
FG	HFGD	100	HFC3B100	42K
		150	HFC3B150	42K
		250	HFC3B250	42K
JG	HJGD	250	HJC3B250	65K
		300	HJC3B300	65K
		350	HJC3B350	65K
		400	HJC3B400	65K
LG	HLGD	400	HLC3B400	65K
		600	HLC3B600	65K
MG	HMGD	600	HMC3B600	65K
		700	HMC3B700	65K
		800	HMC3B800	65K
NG	HNGD	800	HNC3B800	65K
		900	HNC3B900	65K
		1000	HNC3B1000	65K
		1200	HNC3B1200	65K
PG	HPGD	1200	HPC3B1200	65K
		1400	HPC3B1400	65K
		1600	HPC3B1600	65K

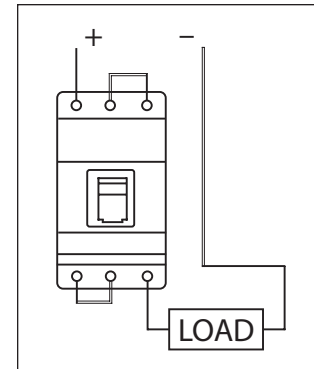

^① Terminal connectors must be ordered separately; see page 17/90.

^② Standard VL breakers DG - PG feature DC ratings up to 500V for ungrounded UPS applications. Consult the individual frame section for more information.

Modularity To Support All Your Application Needs

Modules and More: VL Circuit Breakers with Optional Accessories

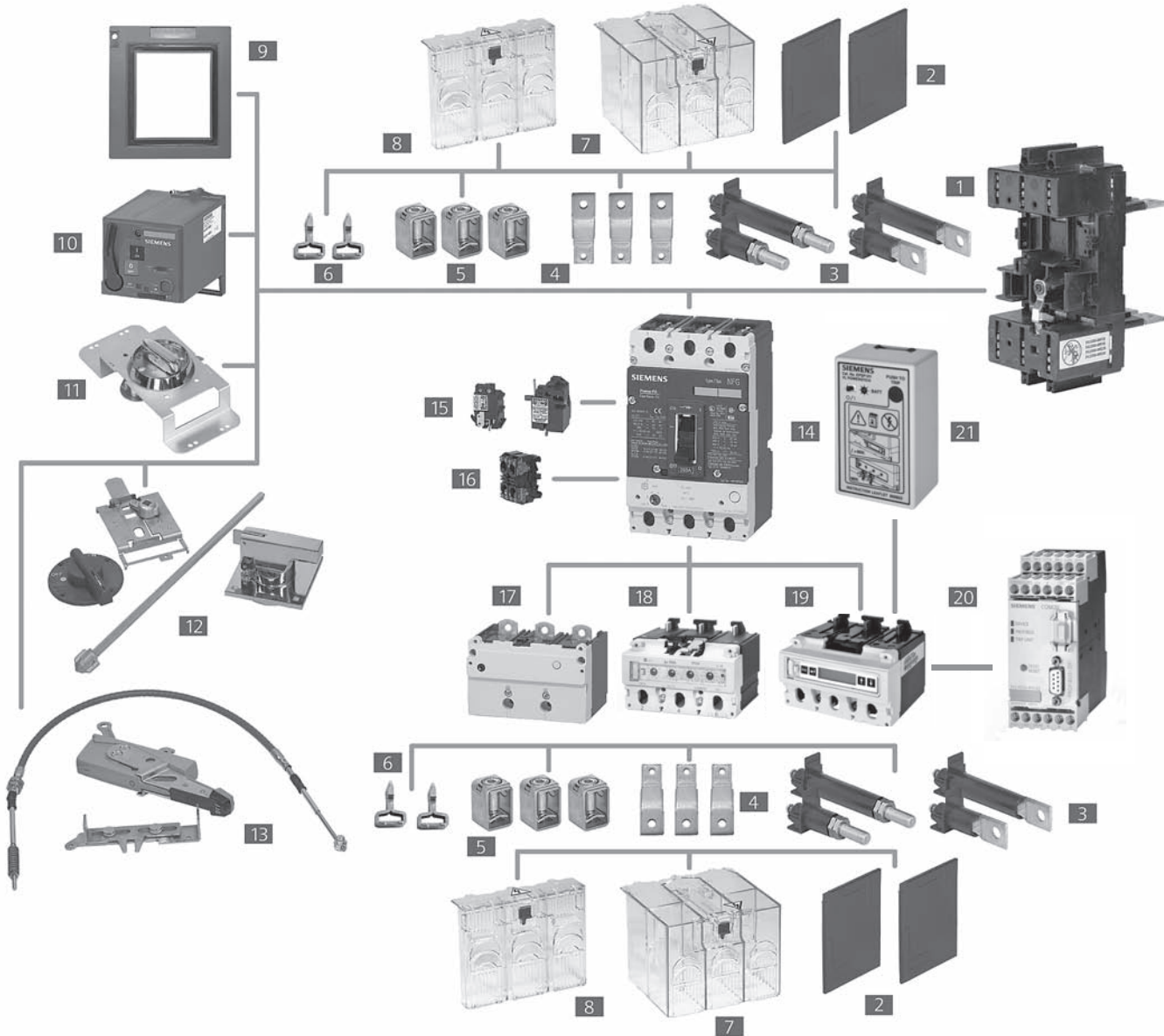

- | | | |
|--|---|--|
| 1 Base for Plug-In or Draw-Out | 9 Cover Frame for Door Cutout | 17 Thermal Magnetic Trip Unit (525) |
| 2 Interphase Barriers | 10 Stored Energy Operator | 18 Electronic Trip Unit (555) |
| 3 Rear Terminals – Flat and Round | 11 Rotary Handle Operator | 19 Elec. Trip Unit with LCD (586) |
| 4 Bus Extensions | 12 Variable Depth Rotary Operator | 20 Communication Module with ZSI |
| 5 Terminal Connectors | 13 Max Flex Operator | 21 Electronic Trip Unit Tester and LCD Power Supply |
| 6 Plug-In Terminal Blades | 14 Circuit Breaker | |
| 7 Extended Terminal Shield | 15 Shunt Trip or Undervoltage Releases | |
| 8 Standard Terminal Shield | 16 Auxiliary/Alarm Switches | |

VL Molded Case Circuit Breakers

Operating Mechanisms

Selection

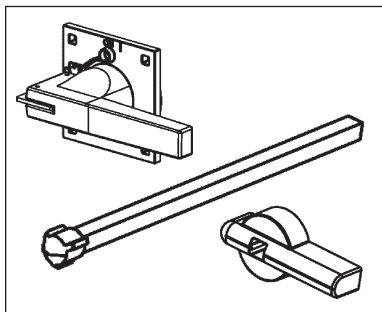
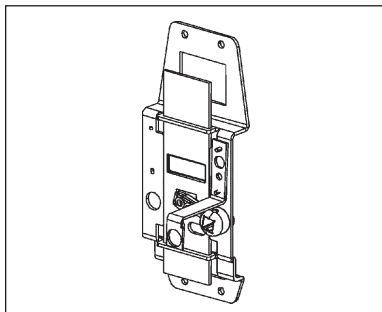
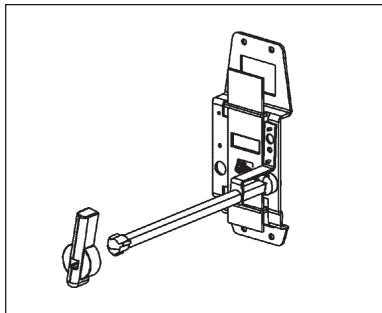
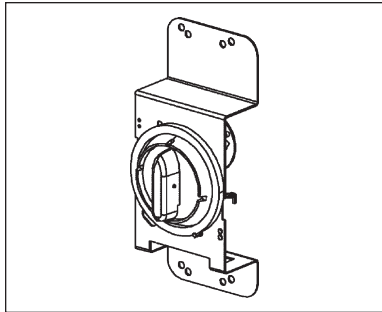

Description	For DG to FG Frame 150 to 250 A		For JG to LG Frame 400 A to 600 A	
	Catalog Number		Catalog Number	
Through-Door Rotary Handle Operator Kit Fixed depth and the handle is mounted directly on the circuit breaker. Lockable knob (for up to 3 padlocks). NEMA 1, 12 Red Handle Version with red knob, yellow indicator plate NEMA 1, 12	RHFF		RHFL	
	RHFFEM		RHFLEM	
Door-Mounted Rotary Handle Operator Kit Variable depth, door mounted handle. Includes knob with masking frame, indicator plate, detachable door coupling, 12" shaft, and breaker mounted rotary operator. Lockable knob (for up to 3 padlocks). NEMA 1, 12	RHVF12		RHVL12	
Auxiliary Switch Kits For Direct or Extended Rotary Handle Operators (RHF and RHV). Form C, Early Break type2 Aux. Switch Kit [Ⓞ] Includes 1 switch with 5' wire For Door-Mounted Operator For Through-Door Operator Includes 2 switches with 5' wire For Door-Mounted Operator For Through-Door Operator	—		RHSLA1	
	RHSFA1F		RHSLA1F	
	—		RHSLA2	
	RHSFA2F		RHSLA2F	
Door-Mounted Rotary Operator Mechanism Breaker mechanism only	RHVFBM		RHVLBM	
Door-Mounted Rotary Handle Only Standard version NEMA 1, 12 NEMA 3R NEMA 4X Red Handle version	RHVM12H		RHVM12H	
	RHVM3RH RHVM4XH RHVMEMH		RHVM3RH RHVM4XH RHVMEMH	
NFPA-79 Handle Kit Intermediate handle for NFPA-79 compliance with door-mounted rotary operator	RHVF79H		RHVM79H	
Extension Shaft Only, for Door Mounted Operator 2 inches (50.8mm) 3 inches (76.2mm) 12 inches (304.8 mm) 16 inches (406.4 mm) 24 inches (609.6mm) w/ support bracket	RHVMS02		RHVMS02	
	—		—	
	RHVMS12		RHVMS12	
	RHVMS16		RHVMS16	
	RHVMS24		RHVMS24	

Ⓞ During manual operation, Early Break auxiliary switch contacts open before the breaker opens.

VL Molded Case Circuit Breakers

Operating Mechanisms

Selection

Description	For MG Frame 800 A	For NG to PG Frame 1200 to 1600 A	
	Catalog Number	Catalog Number	
Through-Door Rotary Handle Operator Kit Fixed depth, breaker mounted. For direct fitting to the circuit breaker. Lockable with up to 3 padlocks. NEMA 1, 12	RHFM —	—	—
Red Handle version with red knob, yellow indicator plate NEMA 1, 12	— —	—	—
Door-Mounted Rotary Handle Operator Kit Variable depth, door mounted handle. Includes knob with masking frame, indicator plate, detachable door coupling, 12" shaft, and breaker mounted rotary operator. Lockable knob (for up to 3 padlocks). NEMA 1, 12	RHVM12	—	—
Auxiliary Switch Kits For Direct or Extended Rotary Handle Operators (RHF and RHV). Early Break type2 Aux. Switch Kit Includes 1 switch with 5' wire For Door-Mounted Operator For Through-Door Operator	RHSMA1 — —	RHSPA1 — —	—
Includes 2 switches with 5' wire For Door-Mounted Operator For Through-Door Operator	RHSMA2 — —	RHSPA2 — —	—
Door-Mounted Rotary Operator Mechanism Breaker mechanism only	RHVMBM	RHVPBM	
Door-Mounted Rotary Handle Only Standard version NEMA 1, 12 NEMA 3R NEMA 4X Red Handle version	RHVM12H RHVM3RH RHVM4XH RHVMEH	RHVP3RH RHVP3RH RHVP4XH RHVPEMH	
NFPA-79 Handle Kit Intermediate handle for NFPA-79 compliance with door-mounted rotary operator	RHVM79H	RHVP79H	
Extension Shaft Only, for Door Mounted Operator 2 inches (50.8mm) 3 inches (76.2mm) 12 inches (304.8 mm) 16 inches (406.4 mm) 24 inches (609.6mm) w/ support bracket	RHVMS02 — — RHVMS12 RHVMS16 RHVMS24	— RHVPS03 RHVPS12 — — RHVPS24	

1
2
3
4
5
6
7
8
9
10
11
12
13
14
15
16
17

VL Molded Case Circuit Breakers

Operating Mechanisms

Selection

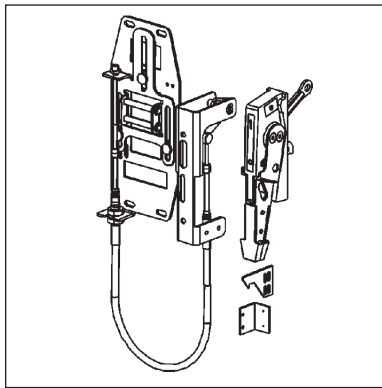
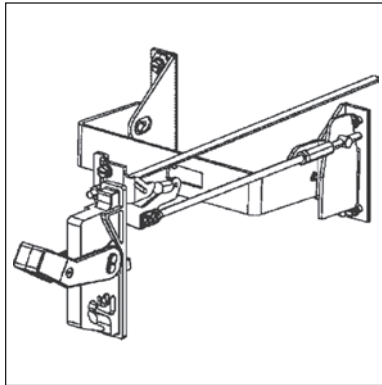

Description	For DG and FG Frame 150 to 250 A	For JG and LG Frame 400 to 600 A
	Catalog Number	Catalog Number
Variable Depth Flange Mounted Operator Kit Adjustable from 8" to 16" Complete kit, includes handle and variable depth operator. IEC Black Handle	FHVF3R FHVF4X FHV3RB FHV4XB	FHVL3R FHVL4X FHV3RB FHV4XB
Max-Flex™, Variable Depth Flange Mounted Operator Kit Complete kit, includes plastic handle, breaker operator, and cable. NEMA 1, 3R, 12 For DG and FG operators, the cable is 36", all others are 48" May be right- or left-hand mounted	MFKF3R	MFKL3R
Handle Only, for Max-Flex™ Variable Depth NEMA 1, 3R, 12 Plastic NEMA 1, 3R, 12 Steel - epoxy coated NEMA 4, 4X Steel - chrome plated Solid color (all gray) Plastic ^① NEMA 1, 3R, 12 Solid color (black handle) Steel epoxy coated ^① NEMA 1, 3R, 12	MFHM3R MFHM3RS MFHM4X MFHM3RB MFHM3RSB	MFHM3R MFHM3RS MFHM4X MFHM3RB MFHM3RSB
Breaker Operator Mechanism Only, for Max-Flex™	MFMF	MFML
Cable Only, for Max-Flex™ Variable Depth 36" 48" 60" 72" 84" 96" 120" 144"	MFCF036 MFCF048 MFCF060 MFCF072 MFCF084 MFCF096 MFCF120 MFCF144	MFCM036 MFCM048 MFCM060 MFCM072 MFCM084 MFCM096 MFCM120 MFCM144
Handle Auxiliary Switch Form C (1NO - 1NC), early break ^② 1 Aux. switch 2 Aux. switch	MFSFA1 MFSFA2	MFSLA1 MFSLA2

① Max-Flex™ handles are available with solid gray or black handles instead of the customary "Red for On" flange handle. The black handle is preferred for IEC markets, where red handles have a specific meaning.

② During manual operation, Early Break aux. contacts open before the breaker opens.

VL Molded Case Circuit Breakers

Operating Mechanisms

Selection

Description	For MG Frame 800 A	For NG Frame 1200 A	For PG Frame 1600 A
	Catalog Number	Catalog Number	Catalog Number
Variable Depth Flange Mounted Operator Kit Adjustable from 8" to 16" Complete kit, includes handle and variable depth operator.			
NEMA 1, 3R, 12	—	—	
NEMA 4X	—	—	
IEC Black Handle	—	—	
NEMA 1, 3R, 12	—	—	
NEMA 4X	—	—	
Max-Flex™, Variable Depth Flange Mounted Operator Kit Complete kit, includes plastic handle, breaker operator, and cable. NEMA 1, 3R, 12 For DG and FG operators, the cable is 36", all others are 48" May be right- or left-hand mounted	MFKM3R	MFKP3RS	MFKP3RS
Handle Only, for Max-Flex™ Variable Depth			
NEMA 1, 3R, 12 Plastic	MFHM3R	—	—
NEMA 1, 3R, 12 Steel - epoxy coated	MFHM3RS	MFHP3RS	MFHP3RS
NEMA 4, 4X Steel - chrome plated	MFHM4X	MFHP4X	MFHP4X
Solid color (all gray) Plastic ^①			
NEMA 1, 3R, 12	MFHM3RB	—	—
Solid color (black handle) Steel epoxy coated ^①			
NEMA 1, 3R, 12	MFHM3RSB	MFHP3RSB	MFHP3RSB
Breaker Operator Mechanism Only, for Max-Flex™	MFMM	MFMP	MFMP
Cable Only, for Max-Flex™ Variable Depth			
36"	MFCM036	—	—
48"	MFCM048	MFCP048	MFCP048
60"	MFCM060	MFCP060	MFCP060
72"	MFCM072	MFCP072	MFCP072
84"	MFCM084	MFCP084	MFCP084
96"	MFCM096	MFCP096	MFCP096
120"	MFCM120	MFCP120	MFCP120
144"	MFCM144	MFCP144	MFCP144
Handle Auxiliary Switch Form C (1NO - 1NC), early break ^② 1 Aux. switch 2 Aux. switch	MFSPA1 MFSPA2	MFSPA1 MFSPA2	MFSPA1 MFSPA2

① Max-Flex™ handles are available with solid gray or black handles instead of the customary "Red for On" flange handle. The black handle is preferred for IEC markets, where red handles have a specific meaning.

② During manual operation, Early Break aux. contacts open before the breaker opens.

VL Molded Case Circuit Breakers

Operating Mechanisms

Selection

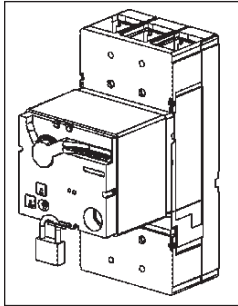

Description	For DG to FG Frame 150 to 250 A													
	Catalog Number													
Stored Energy and Motor Operators Lockable with up to 3 padlocks. <table border="1"> <tr> <td>AC Voltage</td> <td>DC Voltage</td> </tr> <tr> <td>—</td> <td>24</td> </tr> <tr> <td>42-48</td> <td>42-48</td> </tr> <tr> <td>60</td> <td>60</td> </tr> <tr> <td>110-127</td> <td>110-127</td> </tr> <tr> <td>220-250</td> <td>220-250</td> </tr> </table>	AC Voltage	DC Voltage	—	24	42-48	42-48	60	60	110-127	110-127	220-250	220-250	Stored Energy Type SEAFB SEAFM SEAFY SEAFN SEAFR CLKF	
AC Voltage	DC Voltage													
—	24													
42-48	42-48													
60	60													
110-127	110-127													
220-250	220-250													
Cylinder Locks for Field Installation														

Plug-In and Draw-Out Bases

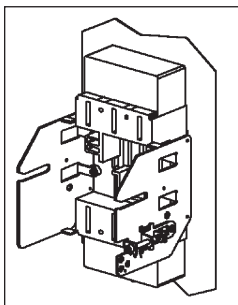
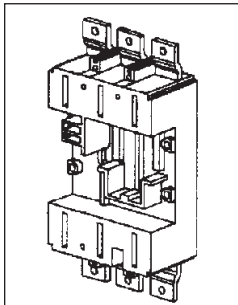
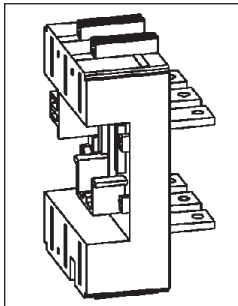

Description	For DG Frame 150 A	For FG Frame 250 A
	Catalog Number	Catalog Number
Plug-in Mounting Base Assembly Includes base, terminal blade kit, sec. terminal block assembly, base trip interlock, and mounting hardware. Rear Connected 3-pole Front Connected 3-pole	PCBDRC3	PCBFRC3
Draw-out Assembly Includes base, position indicator switch, socket, base trip interlock, crank handle, connectors, and necessary shields. Rear Connected 3-pole Front Connected 3-pole (Draw-out assembly includes side plates and all hardware)	DCADRC3	DCAFC3
Hex Wrench for racking draw-out assembly and position indicator	DCHP	DCHP
Position Indicator Switch Form "C" switch to indicate breaker engaged/de-engaged position. ^①	DCIP	DCIP
Secondary Terminal Block Assy. Accessory connections for plug-in or draw-out breakers. Pre-wired plug and block with 8 terminal points. ^②	PCTF83	PCTF83
Plug-In Spare Breaker Kit Set of 6 terminal blades, 2 terminal shield, & 1 trip interlock	PCXD3	PCXF3
Draw-out Spare Breaker Kit Set of 6 terminal blades, & 1 trip interlock	DCXD3	DCXF3
Spare Breaker Trip Interlock	PCXFT	PCXFT

① Up to 2 position indicator switches may be mounted per plug-in or draw-out base.

② Up to 2 plugs per breaker (16 terminal points) may be mounted on DG, and FG breakers. Up to 3 plugs per breaker (24 terminal points) may be mounted on JG, LG, MG, NG, and PG breakers.

VL Molded Case Circuit Breakers

Operating Mechanisms

Selection

For JG to LG Frame 400 to 600 A	For MG Frame 800 A	For NG to PG Frame 1200 to 1600 A		
Catalog Number	Catalog Number	Catalog Number		
Stored Energy Type SEALB SEALM SEALY SEALN SEALR CLKP	Stored Energy Type SEAMB SEAMM SEAMY SEAMN SEAMR CLKP	Motor Operator Type MTRPB MTRPM MTRPY MTRPN MTRPR CLKP		
For JG Frame 400 A	For LG Frame 600 A	For MG Frame 800 A	For NG Frame 1200 A	For PG Frame 1600 A
Catalog Number	Catalog Number	Catalog Number	Catalog Number	Catalog Number
PCBJRC3	PCBLRC3	PCBMRC3	PCBNRC3	—
PCBJFC3	PCBLFC3	—	—	—
DCAJRC3	DCALRC3	DCAMRC3	DCANRC3	—
DCAJFC3	DCALFC3	DCAMFC3	DCANFC3	—
DCHP	DCHP	DCHP	DCHP	—
DCIP	DCIP	DCIP	DCIP	—
PCTL83	PCTL83	PCTM83	PCTN83	—
PCXJ3	PCXL3	PCXM3	PCXN3	—
DCXJ3	DCXL3	DCXM3	DCXN3	—
PCXLT	PCXLT	PCXMT	PCXPT	—

1
2
3
4
5
6
7
8
9
10
11
12
13
14
15
16
17

VL Molded Case Circuit Breakers

Connections

Selection

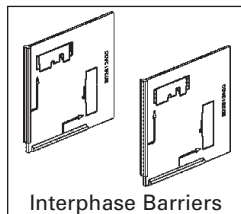
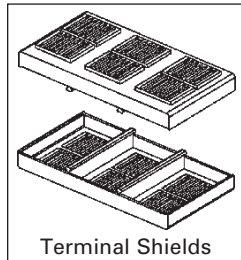
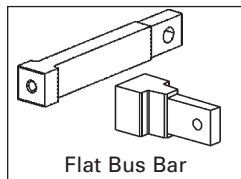
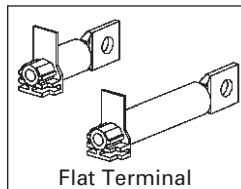
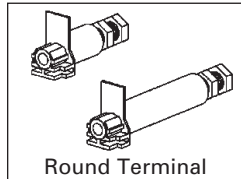
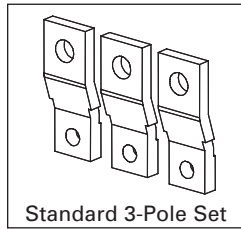

Description	For DG Frame 150 A	For FG Frame 250 A
	Catalog Number	Catalog Number
Front Bus Bar Connections Includes nut keeper plates and shield. Standard (straight) 3-Pole Set Bus Bar Connection Strap Kit Includes 6 - Bus Bars, 6 Nut Keepers & Shields 100% rated applications	FBCE3 — —	FBCE3 — —
Rear-Connecting Studs Short length round term. (1piece) Long length round term. (1piece) 3-Pole round term. kit, 2 short + 1 long Short length flat term. (1piece) Long length flat term. (1piece) 3-Pole flat term. kit, 2 short + 1 long Flat bus bar type (1 piece) 3-Pole set of flat bus bar	RTLDSE RTLDLE SRTDRE RTLDFE RTLDLE SRTDFE — —	RTLFSE RTLFLE SRTFRE RTLDFE RTLFLE SRTDFE — —
Terminal Shields Includes 2 terminal shields. 3-Pole Standard Shield 3-Pole Extended Shield	TSSF3 TSLF3	TSSF3 TSLF3
Interphase Barriers Set of 2 barriers Also fits plug-in and draw-out bases.	IPBF	IPBF
Lug Mounting Assy.	—	—
Breaker Mounting Base Front connected Rear connected	— —	— —

VL Molded Case Circuit Breakers

Connections

Selection

For JG Frame 400 A	For LG Frame 600 A	For MG Frame 800 A	For NG Frame 1200 A	For PG Frame 1600 A
Catalog Number	Catalog Number	Catalog Number	Catalog Number	Catalog Number
FBCJ3 —	FBCL3 —	FBCM3 —	SSBP SSBPH	SSBP SSBPH
RTLJSR RTLJLR SRTJR3 RTLJSF RTLJLF SRTJF3 — —	— — — — — — RTLLSF SRTL3F3	— — — — — — RTLMSF SRTMF3	— — — — — — RTLNSF SRTNF3	— — — — — — — —
TSSL3 TSLL3	TSSL3 ^① TSLL3 ^①	TSSM3 TSLM3	TSSP3 TSLP3	TSSP3 TSLP3
IPBM	IPBM	IPBM	IPBP	IPBP
—	—	—	—	LMAP1600 ^②
— —	— —	— —	— —	MBPG1600 MBPG1601

1
2
3
4
5
6
7
8
9
10
11
12
13
14
15
16
17



① Not for use with standard Al terminals. Use Standard Shield for rear connection and Extended Shield for bus-bar connection.

② Kit includes connection for one side of breaker only. Order quantity 2 if connecting line and load side.

VL Molded Case Circuit Breakers

Connections

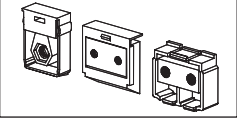
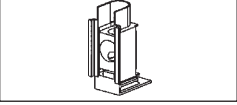
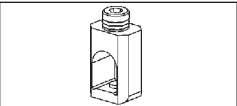
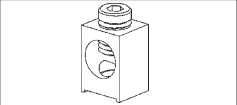
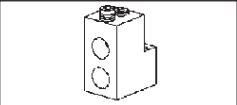
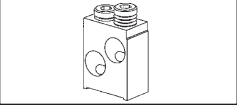
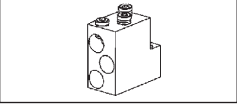
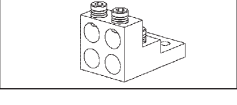
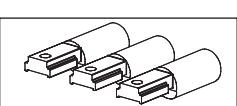
Selection

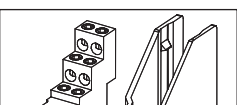
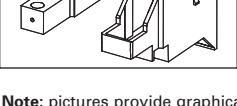
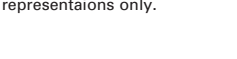
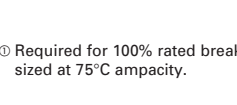
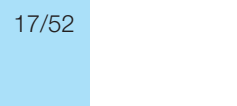
		For DG Frame 150 A	For FG Frame 250 A
	Description	Catalog Number	Catalog Number
 	Nut Keeper Plates For ring/tongue terminal or bus bar connections. (For metric threads on other than the JG frame, change "TNK" to "TMK") 1 Nut Keeper Plate Kit of 3	TNKD TNKD3	TNKF TNKF3
	Mechanical Lugs <i>Steel Wrap Around Body (Cu Wire Only)</i> Cable Size; (cables per phase) Single Lug Kit of 3	#8-1/0; 1-hole TW1DG20 3TW1DG20	#4-350 kcmil; 1-hole TW1FG350 3TW1FG350
	<i>Aluminum Body (Al or Cu Wire)</i> Cable Size; (cables per phase) Single Lug Kit of 2	#6-3/0; 1-hole TA1DG30 —	#4-350 kcmil; 1-hole TAW1FG350 —
	Kit of 3	3TA1DG30	3TAW1FG350
	Cable Size; (cables per phase) Single Lug Kit of 2 Kit of 3	— — — —	— — — —
	Cable Size; (cables per phase) Single Lug	— —	— —
	<i>Copper Body (Cu Wire Only)</i> Cable Size; (cables per phase) Single Lug Kit of 2	#6-3/0; 1-hole TC1DG30 ^① —	#4-350 kcmil; 1-hole TCW1FG350 ^① —
	Kit of 3	3TC1DG30 ^①	3TCW1FG350 ^①
	Cable Size; (cables per phase) Single Lug	— —	— —
	Compression Lugs Cable Size; (cables per phase) Kit of 2 Kit of 3	#14-2/0; 1-cable 2CLD20 3CLD20	#4-350 kcmil; 1-cable — 3CLF350
	Cable Size; (cables per phase) Kit of 2 Kit of 3	— —	— —
	Cable Size; (cables per phase) Kit of 3	— —	— —
	Distribution Lugs (Cu Wire Only) Cable Size; (cables per phase) Single Lug Kit of 3 Cable Size; (cables per phase) Single Lug Kit of 3	#14-#2; 3-hole TA3DG02 3TA3DG02 #14-#4; 6-hole TA6DG04 3TA6DG04	#14-#1; 2-hole and #14-2/0; 1-hole TA3FG20 3TA3FG20 #14-#4; 6-hole TA6FG04 3TA6FG04
	Control Wire Terminals Control Wire Terminal (Single) Control Wire Terminal (Kit of 3)	— —	— —

Note: pictures provide graphical representations only.

① Required for 100% rated breakers. Requires 90°C cable sized at 75°C ampacity.

VL Molded Case Circuit Breakers

Connections

Selection

For JG Frame 400 A	For LG Frame 600 A	For MG Frame 800 A	For NG Frame 1200 A	For PG Frame 1600 A
Catalog Number	Catalog Number	Catalog Number	Catalog Number	Catalog Number
TMKJ TMKJ3 <i>metric only</i>	TNKL TNKL3	TNKM TNKM3	TNKP TNKP3	TNKP TNKP3
1/0-600 kcmil; 1-hole TW1JG600 3TW1JG600	— — —	— — —	— — —	— — —
3/0-250 kcmil; 2-hole TA2JG250 — 3TA2JG250 AL: 250-750 kcmil CU: 3/0-600 kcmil; 1-hole TA1JG750 — 3TA1JG750 — — —	#2-600 kcmil; 2-hole — — — 3TA2LG600LD ^① 3TA2LG600LN ^② AL: 250-750 kcmil CU: 3/0-600 kcmil; 1-hole TA1JG750 (400A max) — 3TA1JG750 (400A max) — — —	1/0-500 kcmil, 3-hole TA3MG500 3TA3MG500 500 -750 kcmil; 2-hole TA2MG750 — 3TA2MG750 #2-600 kcmil; 3-hole — 3TA3MG600 ^③ (Kit of 3)	1/0-500 kcmil; 4-hole — 2TA4NG500 3TA4NG500 3TA4NG500H ^③ 500 -750 kcmil; 3-hole — 2TA3NG750 3TA3NG750 — —	1/0-750 kcmil; 6-hole — — 3TA6PG750 ^④ 600-750 kcmil; 4-hole TA4P750 ^④ — 300-600 kcmil; 5; 6-hole TA5P600 ^④ TA6R600 ^④ —
3/0-250 kcmil; 2-hole TC2JG250 ^③ — — 3/0-750 kcmil; 1-hole TC1JG750 ^③	#2-600 kcmil; 2-hole — — — 3TC2LG600LD ^{①③} 3TC2LG600LN ^{②③} — —	1/0-500 kcmil; 3-hole TC3MG500 ^③ — — — —	1/0-500 kcmil; 4-hole — — 3TC4NG500 ^③ — —	— — — — 300-600 kcmil; 5-hole TC5R600 ^{③④}
#6-350 kcmil; 1-cable — 3CLJ350 250-600 kcmil; 1-cable 3CLJ600 — 250-750 kcmil; 1-cable 3CLJ750 —	#6-350 kcmil; 2-cable — 6CLL350 (kit of 6) 250-750 kcmil; 1-cable 3CLL750 — 250-600 kcmil; 2-cable 6CLL600 (kit of 6) —	— — — — — —	1/0-500 kcmil; 4-cable — 12CLN500 (kit of 12) — — — — —	— — — — — —
#14-#4; 12-hole TA12JG04 3TA12JG04 #14-2/0; 6-hole TA6JG20 3TA6JG20	— — — — —	— — — — —	— — — — —	— — — — —
TA2JG250PT —	— 3TA2LG600LNPT	TA3MG500PT —	— 3TA4NG500PT	— —

All lug kits include the nut keepers.
 ① Mounted on Load Side Only.
 ② Mounted on Line Side Only.

③ Required for 100% rated breakers. Requires 90°C cable sized at 75°C ampacity.
 ④ Requires extended modified shield.

⑤ Used only with LMAP1600 mounting base.
 ⑥ Used only with MBPG1600 or MBPG1601 mounting base.

VL Molded Case Circuit Breakers

General

Selection

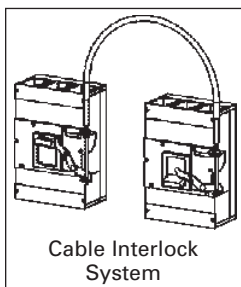
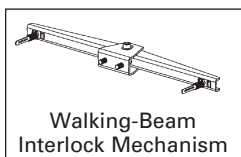
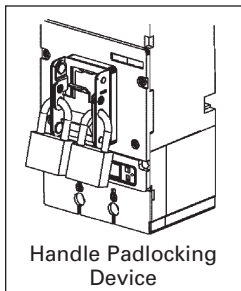

Description	For DG Frame 150 A	For FG Frame 250 A
	Catalog Number	Catalog Number
Handle Padlocking Device To padlock breaker toggle in the "OFF" position. Accepts up to 3 padlocks with 5–8 mm shackles.	HPLF	HPLF
Handle Blocking Device For holding the handle in the "ON" position. Not a lockout/tagout device.	HBDF	HBDF
Walking-Beam Interlock Mechanism Provides mechanical interlocking between two adjacent circuit breakers. Fixed mounted breakers	WBMFFM	WBMFFM
Note: Both breakers must be of the same frame size.		
Cable Interlock Mechanism Provides mechanical interlocking between 2 circuit-breakers - includes operator mechanism for one circuit breaker only. Combination with the next larger or smaller frame size is possible.	CBTF	CBTF
Interlock Cable Cable only, to connect 2 circuit breakers. Cable length 18 in. .46m (recommended up to 250A) Cable length 36 in. .91m (recommended from 400–800A) Cable length 54 in. 1.37m (recommended from 1200–1600A)	CBCF18 CBCM36 CBCP54	CBCF18 CBCM36 CBCP54
Mounting Screw Kit Includes the necessary hardware to mount a circuit breaker to the user's prepared surface Kit with 2 screws (SAE thread) Kit with 4 screws (SAE thread)	MSKF2 MSKF4	MSKF2 MSKF4
Trip Adjustment Sealing Cover Includes a trip unit cover to prevent tampering or adjustment of trip settings. Seal not included. Thermal-Magnetic Trip Units	TSCFTM	TSCFTM

VL Molded Case Circuit Breakers

General

Selection

For JG Frame 400 A	For LG Frame 600 A	For MG Frame 800 A	For NG Frame 1200 A	For PG Frame 1600 A
Catalog Number	Catalog Number	Catalog Number	Catalog Number	Catalog Number
HPLL	HPLL	HPLM	HPLP	HPLP
HBDL	HBDL	HBDM	HBDP	HBDP
WBMLFM	WBMLFM	WBMMFM	WBMPFM	WBMPFM
CBTL	CBTL	CBTM	CBTP	CBTP
— CBCM36 CBCP54	— CBCM36 CBCP54	— CBCM36 CBCP54	— — CBCP54	— — CBCP54
— MSKL4	— MSKL4	— MSKM4	— MSKP4	— MSKP4
TSLTLM	TSLTLM	TSCMTM	—	—

- 1
- 2
- 3
- 4
- 5
- 6
- 7
- 8
- 9
- 10
- 11
- 12
- 13
- 14
- 15
- 16
- 17

VL Molded Case Circuit Breakers

Ground Sensors & Electronic Accessories

Selection

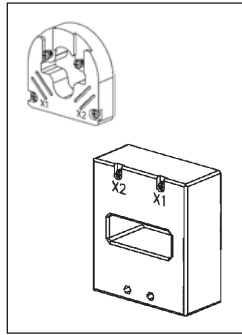

Description

Neutral Current Transformer (Ground Sensor, N-pole)

Neutral = 35/60A
 Neutral = 100A
 Neutral = 150A
 Neutral = 250A
 Neutral = 400A
 Neutral = 600A
 Neutral = 800A
 Neutral = 1000/1200A
 Neutral = 1600A

For DG Frame
150 A

For FG Frame
250 A

Catalog Number

Catalog Number

NGSD060	—
NGSF100	NGSF100
NGSF150	NGSF150
—	NGSJ250
—	—
—	—
—	—
—	—
—	—
—	—

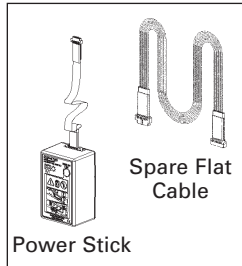

Power Stick

Spare Flat Cable

Communications & Electronics

Power Stick - Hand held, battery operated power supply for LCD trip units. (Requires two 9V batteries.) Trip testing for both 555 & 586 trip units.

Spare flat cable for Power Stick.

COM20 Profibus Communications Module with ZSI for electronic trip units (order cable separately)

COM21 Modbus Communications Module with ZSI for electronic trip units (order cable separately)

Cable for COM20/21, 1.5 m (4.9 ft)

Cable for COM20/21, 3.0 m (9.8 ft)

Addressing Plug - assigns a field bus address without a PC by plugging into COM20/21

EPSP18V

EPSP18V

COMPCA

COMPCA

COMPRO20

COMPRO20

COMMOD21

COMMOD21

COMKIT3

COMKIT3

COMKIT6

COMKIT6

3UF79100AA000

3UF79100AA000



Com20 Profibus & Com21 Modbus Communications Module

Door Cutouts & Extensions

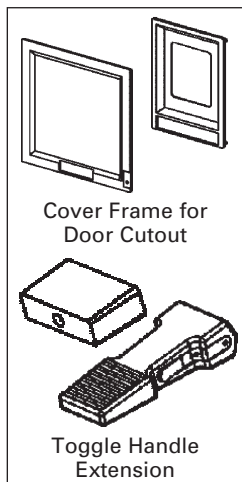

Cover Frame for Door Cutout

Toggle Handle Extension

Cover Frame for Door Cutout

For fixed or plug-in mounted circuit breakers. (IP30)
 2-Pole & 3-Pole

For breakers with stored energy operator. (IP40)

Circuit-breaker draw-out mounted and toggle handle operated. Kit includes cover frame (bezel) and escutcheon as needed. (IP40) (not for use with rotary handle or stored energy operator)

Toggle Handle Extension

For spare or replacement. (One is included with each NG - PG frame.)

BZLF3

BZLF3

BZLFRHSE

BZLFRHSE

BZLFBDC

BZLFBDC

—

—

VL Molded Case Circuit Breakers

Ground Sensors & Electronic Accessories

Selection

For JG Frame 400 A	For LG Frame 600 A	For MG Frame 800 A	For NG Frame 1200 A	For PG Frame 1600 A
Catalog Number	Catalog Number	Catalog Number	Catalog Number	Catalog Number
— — — NGSJ250 NGSL400 — — — —	— — — — NGSL400 NGSM600 — — — —	— — — — — NGSM600 NGSN800 — — —	— — — — — — NGSN800 NGSP120 —	— — — — — — — NGSP120 NGSP160
EPSP18V	EPSP18V	EPSP18V	EPSP18V	EPSP18V
COMPCA	COMPCA	COMPCA	COMPCA	COMPCA
COMPRO20	COMPRO20	COMPRO20	COMPRO20	COMPRO20
COMMOD21	COMMOD21	COMMOD21	COMMOD21	COMMOD21
COMKIT4	COMKIT4	COMKIT5	COMKIT5	COMKIT5
COMKIT7	COMKIT7	COMKIT8	COMKIT8	COMKIT8
3UF79100AA000	3UF79100AA000	3UF79100AA000	3UF79100AA000	3UF79100AA000
BZLL3	BZLL3	BZLM3	BZLP3	BZLP3
BZLLRHSE	BZLLRHSE	BZLMRHSE	BZLPRHSE	BZLPRHSE
BZLLBDC	BZLLBDC	BZLMBDC	BZLPBDC	BZLPBDC
THEL	THEL	THEM	THEP	THEP

- 1
- 2
- 3
- 4
- 5
- 6
- 7
- 8
- 9
- 10
- 11
- 12
- 13
- 14
- 15
- 16
- 17

VL Molded Case Circuit Breakers

Accessory Locations

Selection

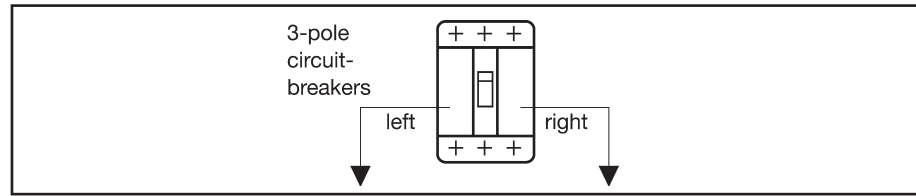

Locations of Internally Mounted Accessories

Frame Family	Left Pocket	Right Pocket
DG*, FG*, JG, LG 150 to 600A	Up to 3 Auxiliary Switches	Shunt Trip or UVR or up to 3 Auxiliary Switches or up to 2 Auxiliary Switches + 1 Alarm Switch
	Up to 2 Auxiliary Switches + 1 Alarm Switch	Shunt Trip or UVR or up to 3 Auxiliary Switches or up to 2 Auxiliary Switches + 1 Alarm Switch
MG, NG, PG 800 to 1600A	Up to 4 Auxiliary Switches	Shunt Trip or UVR or up to 4 Auxiliary Switches
	Up to 2 Auxiliary Switches + 2 Alarm Switches	Shunt Trip or UVR or up to 4 Auxiliary Switches

* Except DG and FG breakers with Electronic Trip Units. Due to the location of the Magnetic Latch, the Left Pocket is not available for accessories.

Accessory Information

- Aux. Switch is an Auxiliary Switch, 1A or 1B contact
- Alarm Switch has 1A or 1B contact
- UVR is an Undervoltage Release
- The standard location for factory mounted Auxiliary and Alarm Switches is the Left Pocket

Accessory Maximums

DG, FG, JG, LG Maximum Accessories:

- Maximum of six (6) switches total
- DG, FG Maximum of two (2) Alarm Switches, one each in the Left and Right Pockets. JG, LG Max. of 1 Alarm, Left only

MG, NG, PG Maximum Accessories:

- Maximum of eight (8) switches total
- Maximum of two (2) Alarm Switches, Left Pocket only

For applications using COMMOD20 and COMMOD21 for communication using Modbus or Profibus

DG, FG

COMKIT3 & COMKIT6 provide auxiliary contact kit. May add only one or two contact blocks for Alarm or Auxiliary function.

JG, LG

COMKIT4 & COMKIT7 provide auxiliary contact kit mounted in left pole pocket. One contact block can be added for Auxiliary function. Right pole pocket available for other release or an additional Auxiliary contact kit.

MG, NG, PG

COMKIT5 & COMKIT8 provide auxiliary contact kit mounted in Left pole pocket. Two contact blocks can be added for Auxiliary function and one for Alarm function. Right pole pocket available for other release or an additional Auxiliary Contact kit.

VL Molded Case Circuit Breakers

Selection

If the frame is:	And you need these functions:	Then add this suffix:	Device Catalog Number
DG, FG, JG or LG	1 Alarm Switch 1 NO Alarm 1 NC Alarm	A1	ASKL1
DG, FG, JG or LG	2 Aux. Switches 1 NO + 1 NC Aux. Contacts	A2	ASKL2
DG, FG, JG or LG	2 Aux. + 1 Alarm Switches 1NO + 1NC Aux. and 1NC Alarm 2NO Aux. and 1NC Alarm	A3	ASKL3
MG, NG or PG	2 Aux. + 2 Alarm Switches 1NO + 1NC Aux. and 1NO + 1NC Alarm 2NO Aux. and 2NC Alarm 2NC Aux. and 2NO Alarm	A3	ASKP3
MG, NG or PG	4 Aux. Switches 2NO + 2NC Aux.	A4	ASKP4

Suffix for factory mounted Shunt Trips

If the frame is:	And you need these functions:	Then add this suffix:	Device Catalog Number
DG, FG, JG or LG	24V DC 48-60V DC 110-127V DC 220-250V DC 48-60V AC 110-127V AC 208-277V AC 380-600V AC	RB RC RD RE RM RN RS RV	STRLB24DC STRLC60DC STRLD125DC STRLE250DC STRLM60 STRLN120 STRLS277 STRLV600
MG, NG or PG	24V DC 48-60V DC 110-127V DC 220-250V DC 48-60V AC 110-127V AC 208-277V AC 380-600V AC	RB RC RD RE RM RN RS RV	STRPB24DC STRPC60DC STRPD125DC STRPE250DC STRPM60 STRPN120 STRPS277 STRPV600

Suffix for factory mounted Undervoltage Releases

If the frame is:	And you need these functions:	Then add this suffix:	Device Catalog Number
DG, FG, JG or LG	12V DC 24V DC 48V DC 60V DC 110-127V DC 220-250V DC 24V AC 110-127V AC 220-240V AC 208V AC 277V AC 380-415V AC 440-480V AC	UA UB UC UG UD UE UL UN UR UP US UT UU	UVRLA12DC UVRLB24DC UVRLC48DC UVRLG60DC UVRLD125DC UVRLE250DC UVRL24 UVRLN120 UVRLR240 UVRLP208 UVRLS277 UVRLT415 UVRLU480
MG, NG or PG	12V DC 24V DC 48V DC 60V DC 110-127V DC 220-250V DC 110-127V AC 220-240V AC 208V AC 277V AC 380-415V AC 440-480V AC	UA UB UC UG UD UE UN UR UP US UT UU	UVRPA12DC UVRPB24DC UVRPC48DC UVRPG60DC UVRPD125DC UVRPE250DC UVRPN120 UVRPR240 UVRPP208 UVRPS277 UVRPT415 UVRPU480

VL Molded Case Circuit Breakers

Technical Data

Selection

		DG	FG	JG	LG	MG	NG	PG
Max rated continuous current		150	250	400	600	800	1200	1600
Rated operational voltage								
NEMA	V AC	600	600	600	600	600	600	600
IEC	V AC	690	690	690	690	690	690	690
Rated Impulse Withstand Voltage								
Main conducting paths	kV	8	8	8	8	8	8	8
Auxiliary circuits	kV	4	4	4	4	4	4	4
Ambient Temperature Range	°C	-25 to +75	-25 to +75	-25 to +75	-25 to +75	-25 to +75	-25 to +75	-25 to +75
High Ambient Derating (thermal-mag.)	50°C	93%	93%	93%	93%	95%	95%	95%
	60°C	86%	86%	86%	86%	86%	86%	80%
	70°C	80%	80%	80%	80%	80%	80%	74%
Operating Cycles		20,000	20,000	20,000	10,000	5,000	3,000	3,000
Max switching rate (per hour)		120	120	120	60	60	30	30
Power loss (at max. rated current)								
Thermal-magnetic	W	15 – 48	32 – 80	60 – 175	85 – 230	170 – 250	150 – 220	200 – 260
Electronic trip unit	W	40	60	90	160	250	210	260
IEC ^①								
Time constant t = 10 ms								
1 current path								
2 current paths in series								
3 current paths in series								
Up to 250V DC		—	—	—	—	—	—	—
440V DC								
600V DC								
NEMA								
Time constant t = 8 ms								
2 poles switching								
1 current path								
250V DC Max. ^②		30	30	30	30	42	42	42
3 poles switching								
2 current paths in series								
500V DC Max. ^②		18	25	35	35	65	65	65
Accessories								
Auxiliary/ Alarm Switch								
Current rating (1 or 2 switches)		10	10	10	10	10	10	10
Current rating (3 or 4 same switch)	A	5	5	5	5	5	5	5
Shunt Trip								
Pick-up voltage	V	0.7 – 1.1	0.7 – 1.1	0.7 – 1.1	0.7 – 1.1	0.7 – 1.1	0.7 – 1.1	0.7 – 1.1
Power Consumption (short-time) at:								
48 – 60 V AC	VA	401 – 501	401 – 501	401 – 501	401 – 501	401 – 501	401 – 501	401 – 501
110 – 127 V AC	VA	424 – 489	424 – 489	424 – 489	424 – 489	424 – 489	424 – 489	424 – 489
208 – 277 V AC	VA	533 – 736	533 – 736	533 – 736	533 – 736	533 – 736	533 – 736	533 – 736
380 – 600 V AC	VA	408 – 645	408 – 645	408 – 645	408 – 645	408 – 645	408 – 645	408 – 645
24 V DC	W	594	594	594	594	594	594	594
48 – 60 V DC	W	740 – 925	740 – 925	740 – 925	740 – 925	740 – 925	740 – 925	740 – 925
110 – 127 V DC	W	559 – 648	559 – 648	559 – 648	559 – 648	559 – 648	559 – 648	559 – 648
220 – 250 V DC	W	722 – 820	722 – 820	722 – 820	722 – 820	722 – 820	722 – 820	722 – 820
Max. Operating time	ms	50	50	50	50	50	50	50

^① Consult Siemens for short circuit values.

^② Review individual frame and type values.

VL Molded Case Circuit Breakers

Technical Data

Selection

		DG	FG	JG	LG	MG	NG	PG
Undervoltage Trip								
Drop voltage (percentage)	V	35% – 70%	35% – 70%	35% – 70%	35% – 70%	35% – 70%	35% – 70%	35% – 70%
Pick-up voltage (percentage)	V	70% – 85%	70% – 85%	70% – 85%	70% – 85%	70% – 85%	70% – 85%	70% – 85%
Power consumption (continuous) at:								
110 – 127 V AC	VA	1	1	1	1	1.1	1.1	1.1
220 – 250 V AC	VA	2.1	2.1	2.1	2.1	2.1	2.1	2.1
208 V AC	VA	1.2	1.2	1.2	1.2	1.2	1.2	1.2
277 V AC	VA	1.4	1.4	1.4	1.4	1.4	1.4	1.4
380 – 415 V AC	VA	1.9	1.9	1.9	1.9	1.9	1.9	1.9
440 – 480 V AC	VA	2.2	2.2	2.2	2.2	2.2	2.2	2.2
500 – 525 V AC	VA	2.5	2.5	2.5	2.5	2.5	2.5	2.5
600 V AC	VA	2.8	2.8	2.8	2.8	2.8	2.8	2.8
Max. opening time	ms	50	50	50	50	50	50	50
Motorized Operating Mechanism								
Motor with stored energy mechanism (synchronizable)		X	X	X	X			
Motor Operator						X	X	X
Max. switching rate (per hour)		120	120	120	60	60	30	30
Command duration	ms	20 – 50	20 – 50	20 – 50	20 – 50	20 – 50	—	—
Closing time	ms	<100	<100	<100	<100	<100	<5,000	<5,000
Charging time	s	<5	<5	<5	<5	<5	<5	<5
Break time	s	<5	<5	<5	<5	<5	<5	<5
Power consumption	VA/W	<500						
Inrush (A)								
Control Voltages 110 – 127 V AC								
220 – 250 V AC								
24 V DC								
48 V DC								
60 V DC								
Operating Range 85 – 110% of rated control voltage								

VL Molded Case Circuit Breakers

Unusual Operating Conditions

Reference

Note: The information provided on this and the next page is intended for reference and recommendation only. Because several variables can act on a circuit breaker's performance at the same time, the data below is based less on controlled testing, than on experience and engineering judgment. Contact Siemens for further information on special conditions and treatment.

High Ambient Temperatures

Because thermal-magnetic trip breakers are temperature sensitive and calibrated for a specific ambient of 40° C (104° F) (average enclosure temperature), a higher ambient will cause the breaker to trip at lower current than its nameplate rating, in other words, causing the breaker to "derate" (see Table 1). Similarly, the current carrying capacity of a circuit conductor is based upon a certain ambient temperature, a higher ambient will reduce its current carrying capacity, causing it to "derate." Thus, with a fluctuating temperature, a thermal-magnetic breaker will derate nearly parallel with its connected circuit conductors and maintain close circuit protection. If the application temperature exceeds 40° C (104° F) and is known, either a breaker specially calibrated for the higher ambient or one oversized according to Table 1 may be selected. In a case such as this, the circuit conductors should be oversized as well.

Siemens Electronic Trip Unit Breakers are insensitive to temperature changes. However, they do include circuitry to protect the components from abnormally high temperatures.

Altitude

Reduced air density at altitudes greater than 6600 ft. (2000 meters) affects the ability of a molded case circuit breaker to transfer heat and interrupt faults. Therefore, circuit breakers applied at these altitudes should have interrupting, insulation and continuous currents derated as indicated in Figure 1.

Table 1 – Temperature derating data for thermal-magnetic breakers

Reference Ampere Rating at 40° C (104° F)	Ampere Rating at:			Siemens Breaker Frames
	25° C (77° F)	50° C (122° F)	60° C (140° F)	
50	55	46	42	DG
60	66	56	52	
70	77	65	60	
90	99	84	78	
100	110	94	87	
125	137	114	100	
150	165	136	120	
175	192	159	140	
200	220	182	160	
225	247	205	180	
250	275	235	220	
300	330	276	252	
350	385	325	301	
400	440	372	340	
500	550	468	435	
600	660	564	525	
700	770	658	613	
800	880	754	704	
900	990	828	749	
1000	1100	900	825	
1200	1320	1090	1000	
1400	1540	1304	1148	
1600	1760	1500	1320	
				FG
				JG
				LG
				MG
				NG
				PG

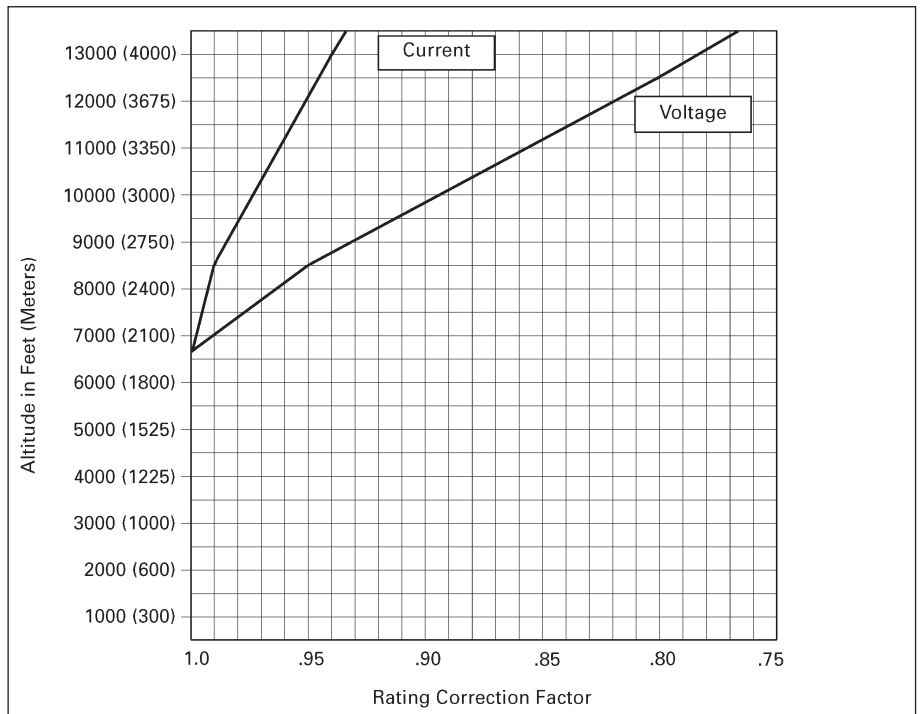

Figure 1 – Altitude adjustment

• Revised •
07/20/14

Sentron Molded Case Circuit Breakers

ED 125A Frame, Sentron Series

Selection

Ordering Instructions

- All ED Frame Sentron circuit breakers are supplied with load side lugs. If line side lugs are required, add "L" suffix to catalog number. Consult Siemens sales office for any additional charge
- 50°C Calibration, 400HZ - see page 17/104. All ED frame circuit breakers may be reverse connected

Type ED2[®]

Blue Label

Continuous Current Rating @ 40°C	1-Pole		2-Pole		3-Pole
	120V AC	125V DC	240V AC	125V DC 250V DC	240V AC
	Catalog Number		Catalog Number		Catalog Number
15	ED21B015 ^④ ■		ED22B015		ED23B015
20	ED21B020 ^④ ■		ED22B020		ED23B020
25	ED21B025■		ED22B025■		ED23B025■
30	ED21B030■		ED22B030		ED23B030
35	ED21B035■		ED22B035■		ED23B035■
40	ED21B040■		ED22B040		ED23B040
45	ED21B045■		ED22B045■		ED23B045■
50	ED21B050■		ED22B050		ED23B050
60	ED21B060■		ED22B060		ED23B060
70	ED21B070■		ED22B070		ED23B070
80	ED21B080■		ED22B080■		ED23B080
90	ED21B090■		ED22B090■		ED23B090■
100	ED21B100■		ED22B100		ED23B100

Shipping Weights

Number of Poles	Number per Carton	Shipping Weight (lbs.)
ED2, ED4, ED6, HED4, HHED6		
1	30	38
2	10	25
3	10	38
CED6		
2	5	20
3	5	30

Type ED4[®]

Blue Label

Continuous Current Rating @ 40°C	1-Pole		2-Pole		3-Pole
	120V AC	125V DC	480V AC	250V DC	480V AC
	Catalog Number		Catalog Number		Catalog Number
15	ED41B015 ^④		—		ED43B015
20	ED41B020 ^④		ED42B020		ED43B020
25	ED41B025		ED42B025		ED43B025
30	ED41B030		ED42B030		ED43B030
35	ED41B035■		ED42B035■		ED43B035
40	ED41B040		ED42B040		ED43B040
45	ED41B045■		ED42B045■		ED43B045
50	ED41B050		ED42B050		ED43B050
60	ED41B060		ED42B060		ED43B060
70	ED41B070		ED42B070		ED43B070
80	ED41B080■		ED42B080■		ED43B080
90	ED41B090■		ED42B090■		ED43B090
100	ED41B100		ED42B100		ED43B100
110	—		ED42B110■		ED43B110
125	—		ED42B125		ED43B125

Lugs

Ampere Rating	No. of Poles	Catalog Number	Wire Range
Aluminum Body Lugs			
All 15–25A	1, 2, 3	Line/Load SA1E025	#14–#10 Cu #12–#10 Al
All 30–100A	1, 2, 3	Line Side LN1E100	#10–#4 Cu/Al
ED2, 4, CED6 30–60A	1	Load Side LD1E060	#10–#4 Cu/Al
ED2, 4, CED6 70–100A	1	Load Side LD1E100	#6–#1/0 Cu/Al
ED2, 4, HED4, HHED6 30–100A	2, 3	Load Side LN1E100	#10–#4 Cu/Al
ED6 20–50A	2, 3	Line Side LN1E100	#10–#4 Cu/Al
All 110, 125A	2, 3	Line/Load TA1E6125	#3–#3/0 Cu #1–#2/0 Al
Copper Body Lugs			
All 30–125A	1, 2, 3	Line/Load TC1ED6150 ^③	#10–#4 Cu only
Compression Lugs			
All ED, HHED, CED		CCE125	2/0

Type ED6[®]

Blue Label

Continuous Current Rating @ 40°C	1-Pole ^①		2-Pole		3-Pole
	347V AC		600V AC	250V DC	600V AC 500V DC
	Catalog Number		Catalog Number		Catalog Number
15	ED61B015		—		ED63B015
20	ED61B020		ED62B020		ED63B020
25	ED61B025		ED62B025■		ED63B025
30	ED61B030		ED62B030		ED63B030
35	ED61B035		ED62B035■		ED63B035
40	ED61B040		ED62B040■		ED63B040
45	ED61B045■		ED62B045■		ED63B045
50	ED61B050		ED62B050■		ED63B050
60	ED61B060		—		ED63B060
70	ED61B070■		—		ED63B070
80	ED61B080		—		ED63B080
90	ED61B090		—		ED63B090
100	ED61B100■		—		ED63B100
110	—		—		ED63B110
125	—		—		ED63B125

Enclosures (Neutral Included)^⑥

Type	Catalog Number
1 (Surface)	E2N1S (15–100A)
1 (Flush)	E2N1F (15–100A)
3R	E2N3R (15–100A)
4–4X	ED6SS4 (15–100A)
7–9	EA (15–60A)
7–9	EB (70–100A)
12	E2N12 (15–100A)
1 (Surface)	CED6N1S ^②
1 (Flush)	CED6N1F ^②
3R	CED6N3R ^②
12	CED6N12 ^②

Note: ED frame circuit breakers qualified to UL 489 Supplement SB "Naval"— See page 17/104 for additional information

- Built to order. Allow 2–3 weeks for delivery.
- ① CSA Certified only (Not UL)

② For CED types and all 110–125 ampere ED frames.

③ See Note: A, page 17/101.

④ SWD rated.

⑤ HACR rated.

⑥ Not for use with HHED6 breakers.

Modifications page 17/104

Accessories pages 17/65 and 17/108 to 17/113

Sentron Molded Case Circuit Breakers

ED 125A Frame Sentron Series

Selection/Dimensions

Type HED4[Ⓞ]

Black Label

Continuous Current Rating @ 40°C	1-Pole		2-Pole		3-Pole
	277V AC 125V DC		480V AC	250V DC	480V AC
	Catalog Number		Catalog Number		Catalog Number
15	HED41B015 [Ⓞ]		HED42B015		HED43B015
20	HED41B020 [Ⓞ]		HED42B020		HED43B020
25	HED41B025		HED42B025■		HED43B025
30	HED41B030		HED42B030		HED43B030
35	HED41B035■		HED42B035■		HED43B035
40	HED41B040		HED42B040		HED43B040
45	HED41B045■		HED42B045■		HED43B045
50	HED41B050■		HED42B050		HED43B050
60	HED41B060■		HED42B060■		HED43B060
70	HED41B070■		HED42B070■		HED43B070
80	HED41B080■		HED42B080■		HED43B080
90	HED41B090■		HED42B090■		HED43B090
100	HED41B100■		HED42B100■		HED43B100
110	—		HED42B110■		HED43B110
125	—		HED42B125■		HED43B125

FIGURE 1 - ED, HED, HHED

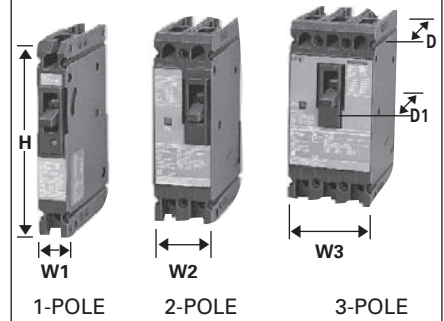
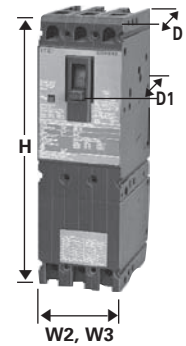

FIGURE 2 - CED (3-Pole shown)



Fuseless Current Limiting

Type HHED6[Ⓞ]

Black Label

Type CED6[Ⓞ]

Red Label

Continuous Current Rating @ 40°C	3-Pole		2-Pole	3-Pole
	600V AC		600V AC, 250V DC	600V AC, 500V DC [Ⓞ]
	Catalog Number [Ⓞ]		Catalog Number	Catalog Number
15	HHED63B015A		CED62B015	CED63B015
20	HHED63B020		CED62B020■	CED63B020
25	HHED63B025		—	—
30	HHED63B030		CED62B030■	CED63B030
35	HHED63B035		—	—
40	HHED63B040		CED62B040■	CED63B040
45	HHED63B045		—	—
50	HHED63B050		CED62B050■	CED63B050
60	—		CED62B060■	CED63B060
70	—		CED62B070■	CED63B070
80	—		CED62B080■	CED63B080
90	—		CED62B090■	CED63B090
100	—		CED62B100■	CED63B100
110	—		—	CED63B110■
125	—		CED62B125■	CED63B125

Dimensions (in inches)

Breaker Type	W1	W2	W3	H	D	D1
Figure 1 ED2, ED4, ED6, HED4, ED6 ETI [Ⓞ]	1	2	3	6.35	3.92	4.56
Figure 1 HHED6	—	2	3	6.53	3.92	4.56
Figure 2 CED6, CED6 ETI [Ⓞ]	—	2	3	9.58	3.92	4.56

Interrupting Ratings

Breaker Type	UL 489 AIR (File #E10848)									IEC 947-2					
	RMS Symmetrical Amperes (KA)									Volts AC (50/60Hz)					
	Volts AC			Volts DC						220/240		380/415		500	
	120	240	277	347	480	600	125	250	500 [Ⓞ]	Icu	Ics	Icu	Ics	Icu	Ics
ED2 (1-P)	10	—	—	—	—	—	5	—	—	—	—	—	—	—	—
ED2 (2, 3-P)	—	10	—	—	—	—	—	5 (2-P)	—	—	—	—	—	—	—
ED4 (1-P)	65	—	22	—	—	—	30	—	—	—	—	—	—	—	—
ED4 (2, 3-P)	—	65	—	—	18	—	—	30 (2-P)	—	—	—	—	—	—	—
ED6 (1-P)	—	—	—	30 [Ⓞ]	—	—	—	—	—	—	—	—	—	—	—
ED6 (2, 3-P)	—	65	—	—	25	18	—	—	18 (3-P)	65	17	35	9	18	5
HED4 (1-P) (15-30A)	100	—	65	—	—	—	30	—	—	—	—	—	—	—	—
HED4 (1-P) (35-100A)	100	—	25	—	—	—	30	—	—	—	—	—	—	—	—
HED4 (2, 3-P) [Ⓞ]	—	100	—	—	42	—	—	30 (2-P)	—	—	—	—	—	—	—
HHED6 (2, 3-P) [Ⓞ]	—	100	—	—	65	18 [Ⓞ]	—	—	—	—	—	—	—	—	—
CED6 (2, 3-P)	—	200	—	—	200	100	—	50 (2-P)	50 (3-P)	—	—	—	—	—	—

■ Built to order. Allow 2-3 weeks for delivery.

ⓄSWD rated.

ⓄWhen wired as shown on page 17/5, this circuit breaker is UL listed and rated for use on 500V DC ungrounded UPS systems.

Ⓞ HED4 and HHED6 type circuit breakers meet the UL criteria for "current limiting" at 240V AC.

Ⓞ ED6-ETI, CED6-ETI, see page 17/91 for ordering information.

Ⓞ Single Pole 15-30A 30KA @ 347V non-UL. 35-100A 18KA @ 347V non-UL.

Ⓞ HACR rated.

Ⓞ HHED63B015A is rated 18KAIC at 600/347V.

Accessories for:

ED 125A Frame



Combinations

Available only when ordered together. Only one module can be added to a breaker. Additional accessories, which always attach to the left pole, cannot be added to the combination later. Adds 1 inch pole space.

Equipment Ground Sensing

A field addable kit containing 30mA or 5 mA ground fault accessory module, current transformer with 24 inch leads, and current transformer mounting equipment. Current transformer to mount in gutter of lighting panel or any control panel. Accessory module operates from separate 120V control power source.

Both 30MA and 5MA devices are equipment protection devices only. Do not use for personnel protection.



Shunt Trip Combinations

Control Voltage		1 Shunt Trip	1 Shunt Trip and 1 Auxiliary Switch	1 Shunt Trip and 1 Auxiliary Switch and 1 Alarm Switch	1 Shunt Trip and 1 Alarm Switch	1 Shunt Trip and 2 Auxiliary Switches
AC	DC	Catalog Number	Catalog Number	Catalog Number	Catalog Number	Catalog Number
24		S17ED60	—	—	—	—
48		S18ED60	—	—	—	—
120		S01ED60	S01ED62A	S01ED62AB	S01ED62B	S01ED62AA
208		—	S02ED62A▲	S02ED62AB▲	S02ED62B▲	S02ED62AA▲
240		S03ED60	S03ED62A	S03ED62AB	S03ED62B▲	S03ED62AA▲
277		S15ED60▲	S15ED64A▲	S15ED64AB▲	S15ED64B▲	—
480		S04ED60	S04ED64A▲	S04ED64AB▲	S04ED64B▲	—
	12	S16ED60▲	S16ED62A▲	—	—	—
	24	S07ED60	S07ED62A	S07ED62AB▲	S07ED62B▲	S07ED62AA▲
	48	S09ED60▲	S09ED62A▲	S09ED62AB▲	S09ED62B▲	S09ED62AA▲
	125	S11ED60▲	S11ED62A▲	S11ED62AB▲	S11ED62B▲	S11ED62AA▲
	250	S13ED60▲	S13ED62A▲	S13ED62AB▲	S13ED62B▲	S13ED62AA▲

Undervoltage Trip Combinations

Control Voltage		1 Undervoltage Trip	1 Undervoltage Trip and 1 Auxiliary Switch	1 Undervoltage Trip and 1 Alarm Switch	1 Undervoltage Trip and 1 Alarm Switch	1 Undervoltage Trip and 2 Auxiliary Switches
AC	DC	Catalog Number	Catalog Number	Catalog Number	Catalog Number	Catalog Number
120		U01ED60	U01ED62A	U01ED62AB▲	U01ED62B▲	U01ED62AA▲
208		U02ED60▲	U02ED62A▲	U02ED62AB▲	U02ED62B▲	U02ED62AA▲
240		U03ED60	U03ED62A▲	U03ED62AB▲	U03ED62B▲	U03ED62AA▲
277		U16ED60▲	U16ED64A▲	U16ED64AB▲	U16ED64B▲	—
480		U06ED60▲	U06ED64A▲	U06ED64AB▲	U06ED64B▲	—
600		U08ED60▲	—	—	—	—
	24	U13ED60	U13ED62A▲	U13ED62AB▲	U13ED62B▲	U13ED62AA▲
	48	U14ED60▲	U14ED62A▲	U14ED62AB▲	U14ED62B▲	U14ED62AA▲
	125	U10ED60▲	U10ED62A▲	U10ED62AB▲	U10ED62B▲	U10ED62AA▲
	250	U12ED60▲	U12ED62A▲	—	—	U12ED62AA▲

Auxiliary Switch Combinations

Maximum Voltage		1 Auxiliary Switch	1 Alarm Switch and 1 Auxiliary Switch	2 Auxiliary Switches	1 Alarm Switch and 2 Auxiliary Switches
AC	DC	Catalog Number	Catalog Number	Catalog Number	Catalog Number
240	250	A01ED62	A01ED62B	A02ED62	A02ED62B
480		A01ED64	A01ED64B	—	—

Maximum Voltage		1 Auxiliary Switch
AC	DC	Catalog Number
	12	A01EDLV

Gold Plated Contacts—for PLC use

Alarm Switch Only

Maximum Voltage		1 Alarm Switch
AC	DC	Catalog Number
240	250	B00ED62
480		B00ED64

Ground Fault Sensing Relay Kit — Equipment Protection Only

For Use With Breaker Frame	Number of Poles	Description	Catalog Number	
			30mA	5mA
CED6, ED2, ED4 ED6, EFC, EFF, HED4, HHED6	1, 2, 3	Basic Kit	GF01ED60	GF01ED65
		Basic Kit with Normally Open Bell Alarm	GF01ED60B0	GF01ED65B0▲
		Basic Kit with Normally Closed Bell Alarm	GF01ED60BC	GF01ED65BC▲

▲ Built to order. Allow 6–8 weeks for delivery.

Sentron Molded Case Circuit Breakers

Accessories

• Revised •
07/20/14

Selection

Type FXD6-A^{①⑦}

Blue Label

Non-Interchangeable Trip (Assembled Circuit Breaker – Without Lugs)		
Continuous Current Rating @ 40°C	2-Pole	3-Pole
	Catalog Number	Catalog Number
70	FXD62B070■	FXD63B070
80	FXD62B080■	FXD63B080
90	FXD62B090■	FXD63B090
100	FXD62B100	FXD63B100
110	FXD62B110■	FXD63B110
125	FXD62B125	FXD63B125
150	FXD62B150	FXD63B150
175	FXD62B175	FXD63B175
200	FXD62B200	FXD63B200
225	FXD62B225	FXD63B225
250	FXD62B250	FXD63B250

Type FD6-A^⑦

Blue Label

Interchangeable Trip			
Continuous Current Rating @ 40°C	Complete Breaker Unassembled w/Lugs	Frame Only	Trip Unit Only
	Catalog Number	Catalog Number	Catalog Number

2-Pole 600V AC, 250V DC^②

70	FD62B070■	FD62F250	FD62T070■
80	FD62B080■		FD62T080■
90	FD62B090■		FD62T090■
100	FD62B100■		FD62T100■
110	FD62B110■		FD62T110■
125	FD62B125■		FD62T125■
150	FD62B150		FD62T150
175	FD62B175■		FD62T175■
200	FD62B200		FD62T200
225	FD62B225■		FD62T225■
250	FD62B250■	FD62T250■	

3-Pole 600V AC, 500V DC^③

70	FD63B070■	FD63F250	FD63T070■
80	FD63B080■		FD63T080■
90	FD63B090■		FD63T090■
100	FD63B100		FD63T100
110	FD63B110■		FD63T110■
125	FD63B125		FD63T125
150	FD63B150		FD63T150
175	FD63B175		FD63T175
200	FD63B200		FD63T200
225	FD63B225		FD63T225
250	FD63B250	FD63T250	

Interrupting Ratings

Breaker Type	RMS Symmetrical Amperes (KA)										
	UL 489 AIR (File E10848)					IEC 947-2					
	Volts AC (50/60Hz)			Volts DC		Volts AC (50/60Hz)					
	240	480	600	250	500 ^④	220/240	380/415	500			
					l _{cu}	l _{cs}	l _{cu}	l _{cs}	l _{cu}	l _{cs}	
FXD6-A, FD6-A	65	35	22	30 (2-P)	18 (3-P)	65	33	35	9	—	—
HFXD6 ^⑤ , HFD6 ^⑤	100	65	25	30 (2-P)	25 (3-P)	100	50	65	33	—	—
HHFD6 ^⑤ , HHFXD6 ^⑤	200	100	25	—	—	—	—	—	—	—	—
CFD6	200	200	100	30 (2-P)	50 (3-P)	—	—	—	—	—	—

Instantaneous Adjustment Trip Range

Breaker Ampere Rating	Nominal Instantaneous Values							±20% Tolerance High
	±20% Tolerance Low	2	3	4	5	6	7	
70-90	600	640	690	730	770	810	850	900
100-110	700	770	840	920	990	1060	1140	1200
125-150	800	900	1000	1100	1200	1300	1400	1500
175-200	900	1060	1210	1370	1520	1780	1930	2000
225-250	1100	1300	1500	1700	1900	2100	2300	2500

Note: FD frame qualified to UL489 supplement SB "NAVAL".
See page 7-91 for additional information.

Ordering Information

Complete Breaker Unassembled with Lugs
Prices of FD6, HFD6, and HHFD6 breakers includes frame, trip and both line and load lugs (TA1FD350A). When ordered by these catalog numbers, the customer will receive the frame, trip, and lugs separately packaged. For applications requiring different lugs, order individual items as needed.

Complete Breaker Assembled without Lugs

Prices of FXD6, HFXD6, HHFXD6, and CFD6 includes frame with non-interchangeable trip unit installed only. Order required lugs separately. For line and load lugs (TA1FD350A) installed, add suffix "L" to catalog number (add 2 times list price of lugs for each pole).

50°C Applications see page 7-91.

400 Hz Applications see page 7-91.

Lugs For 75°C Wire^⑤

Catalog Number	Wire Range
TA1FD350A	#6—350 kcmil Cu #4—350 kcmil Al
TC1FD350	#6—350 kcmil Cu
Compression Lug	
CCF250	350 kcmil Cu/Al

Enclosures

Type	Catalog Number
1	F6N1S(F)
3R	F6N3R
4-4X	FD6SS4
7-9	EC2
12	F6N12
Neutral ^⑥	N250

Modifications page 7-91
Enclosures Section 6
Accessories pages 7-50 and 7-95 to 7-100

■ Built to order. Allow 2–3 weeks for delivery.

- ① Type FXD6-A circuit breakers are UL Listed for reverse fed applications.
- ② 2-pole units are 3-pole width.
- ③ When wired as shown on page 7-4, this circuit breaker is UL listed and rated for use on 500V DC ungrounded UPS systems only.
- ④ Order neutral as separate item.
- ⑤ See Note: A, page 7-88.
- ⑥ HFD6 and HHFD6 type circuit breakers meet the UL criteria for "current limiting" at 240 and 480V AC.
- ⑦ HACR rated.

Sentron Molded Case Circuit Breakers

FD 250A Frame Sentron Series

Selection/Dimensions

Type HFD6, Type HFXD6^{②③④⑤⑥}

Black Label

Interchangeable Trip			
Continuous Current Rating @ 40°C	Complete Breaker Unassembled w/Lugs	Frame Only	Trip Unit Only
	Catalog Number	Catalog Number	Catalog Number

2-Pole 600V AC, 250V DC (3-Pole Width)

Current Rating	Complete Breaker Unassembled w/Lugs	Frame Only	Trip Unit Only
70	HFD62B070■	HFD62F250	FD62T070■
80	HFD62B080■		FD62T080■
90	HFD62B090■		FD62T090■
100	HFD62B100■		FD62T100■
110	HFD62B110■		FD62T110■
125	HFD62B125■		FD62T125■
150	HFD62B150■		FD62T150■
175	HFD62B175■		FD62T175■
200	HFD62B200■		FD62T200■
225	HFD62B225■		FD62T225■
250	HFD62B250■		FD62T250■

3-Pole 600V AC, 500V DC^①

Current Rating	Complete Breaker Unassembled w/Lugs	Frame Only	Trip Unit Only
70	HFD63B070■	HFD63F250	FD63T070■
80	HFD63B080■		FD63T080■
90	HFD63B090■		FD63T090■
100	HFD63B100■		FD63T100■
110	HFD63B110■		FD63T110■
125	HFD63B125■		FD63T125■
150	HFD63B150■		FD63T150■
175	HFD63B175■		FD63T175■
200	HFD63B200■		FD63T200■
225	HFD63B225■		FD63T225■
250	HFD63B250■		FD63T250■

Type HHFD, HHFXD6^{②③④⑥}

3-Pole 600V AC, Extra High Interrupting

Current Rating	Complete Breaker Unassembled w/Lugs	Frame Only	Trip Unit Only
70	HHFD63B070■	HHFD63F250	FD63T070■
80	HHFD63B080■		FD63T080■
90	HHFD63B090■		FD63T090■
100	HHFD63B100■		FD63T100■
110	HHFD63B110■		FD63T110■
125	HHFD63B125■		FD63T125■
150	HHFD63B150■		FD63T150■
175	HHFD63B175■		FD63T175■
200	HHFD63B200■		FD63T200■
225	HHFD63B225■		FD63T225■
250	HHFD63B250■		FD63T250■

Type CFD6-A^{③⑥}

Fuseless Current Limiting

Red Label

Non-Interchangeable Trip (Assembled Circuit Breaker without Lugs)	
Continuous Current Rating @ 40°C	3-Pole 600V AC/500V DC
	Catalog Number
70	CFD63B070■
80	CFD63B080■
90	CFD63B090■
100	CFD63B100■
110	CFD63B110■
125	CFD63B125■
150	CFD63B150■
175	CFD63B175■
200	CFD63B200■
225	CFD63B225■
250	CFD63B250■

■ Built to order. Allow 2-3 weeks for delivery.

① When wired as shown on page 17/5, this circuit breaker is UL listed and rated for use on 500V DC ungrounded UPS systems.

② For non-interchangeable trip 3-pole HFD6 type circuit

breaker, change prefix identifier from HFD6 to HFXD6. Price equals frame and trip prices combined, e.g. price of HFXD63B250 equals price of HFD63F250 plus price of FD63T250. Order lugs separately.

③ Type HFXD6, HHFXD6, CFD6 are UL Listed for reverse feed applications.

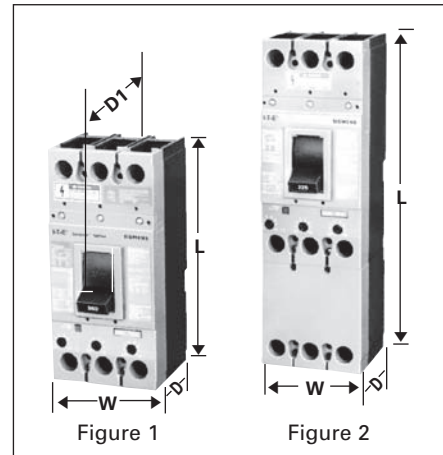

Dimensions (in inches)

Breaker Type	W	L	D	D1 (to handle)
Figure 1 FXD6-A, FD6-A, HFD6, HFXD6, HHFD6, FD6-ETI ^⑤	4.50	9.50	4	5.25
Figure 2 CFD6, CFD6-ETI ^⑤	4.50	14.25	4	5.25

Shipping Weights

Number of Poles	Number per Carton	Shipping Weight (lbs.)
FD6-A, HFD6, HHFD6, FXD6-A Assembled Circuit Breaker (less connectors)		
2	1	8.6
3	1	10
FD6-A, HFD6, HHFD6 Frame Only		
2	1	7.5
3	1	8.7
FD6 Trip Unit Only		
2	1	1.1
3	1	1.3
CFD6 Assembled Circuit Breaker (less terminals)		
3	1	16

④ Type HFXD6, HFD6, HHFD6, HHFXD6 meet the UL criteria for "Current Limiting" at 240 VAC and 480V AC.

⑤ FXD6, ETI, CFD6, ETI — See page 17/91 for ordering information.

⑥ HACR rated.

Sentron Molded Case Circuit Breakers

Internal Accessories

Selection

Accessories:
for FD, FFC & FFF 250A Frames



Shunt Trip Combinations

Control Voltage		1 Shunt Trip
AC	DC	Catalog Number
24		S17FD60
120		S01FD60
240		S03FD60
277		S15FD60▲
480		S04FD60
600		S06FD60▲
	12	S16FD60▲
	24	S07FD60
	48	S09FD60▲
	125	S11FD60
	250	S13FD60▲

Undervoltage Trip Combinations

Control Voltage		1 Undervoltage Trip	1 Undervoltage Trip and 1 Auxiliary Switch
AC	DC	Catalog Number	Catalog Number
120		U01FD60	W01FD64
208		U02FD60▲	W02FD64▲
240		U03FD60	W03FD64▲
277		U16FD60▲	W16FD64▲
480		U06FD60▲	W06FD64▲
600		U08FD60▲	—
	24	U13FD60	W13FD64
	48	U14FD60▲	W14FD64▲
	125	U10FD60▲	W10FD64▲
	250	U12FD60▲	W12FD64▲

Auxiliary Switch Combinations

Voltage		1 Auxiliary Switch	2 Auxiliary Switches
AC	DC	Catalog Number	Catalog Number
240		A01FD62	A02FD62
480		A01FD64	A02FD64
	12	A01FDLV	Gold Plated Contacts - for PLC use

Alarm Switch Combinations

Maximum Voltage		1 Alarm Switch	1 Alarm Switch and 1 Auxiliary Switch
AC	DC	Catalog Number	Catalog Number
480	250	B00FD64	C01FD64

▲ Built to order. Allow 6–8 weeks for delivery.

Ⓞ Auxiliary switch application is for 480V AC maximum.

Note: Old F-frame accessories cannot be used in new Sentron line. Likewise, new FD-frame accessories cannot be used on old F-frame circuit breakers.

Sentron Molded Case Circuit Breakers

JD 400A Frame Sentron Series

Selection

Type JXD2-A^①

240V AC, 2-Pole 250V DC Only

Blue Label

Non-Interchangeable Trip (Assembled Circuit Breaker without Lugs)		
Continuous Current Rating @ 40°C	2-Pole (3-Pole Width) Catalog Number	3-Pole Catalog Number
200	JXD22B200■	JXD23B200
225	JXD22B225■	JXD23B225
250	JXD22B250■	JXD23B250
300	JXD22B300	JXD23B300
350	JXD22B350■	JXD23B350
400	JXD22B400	JXD23B400

Type JXD6-A^{①⑤}

600V AC, 2-Pole 250V DC, 3-Pole 500V DC^②

Blue Label

Non-Interchangeable Trip (Assembled Circuit Breaker without Lugs)		
Continuous Current Rating @ 40°C	2-Pole (3-Pole Width) Catalog Number	3-Pole Catalog Number
200	JXD62B200■	JXD63B200
225	JXD62B225■	JXD63B225
250	JXD62B250■	JXD63B250
300	JXD62B300	JXD63B300
350	JXD62B350■	JXD63B350
400	JXD62B400	JXD63B400

Type JD6-A^⑤

Blue Label

Interchangeable Trip			
Continuous Current Rating @ 40°C	Complete Breaker Unassembled w/Lugs	Frame Only	Trip Unit Only
	Catalog Number	Catalog Number	Catalog Number
200	JD62B200■	JD62F400	JD62T200■
225	JD62B225■		JD62T225■
250	JD62B250■		JD62T250■
300	JD62B300■		JD62T300■
350	JD62B350■		JD62T350■
400	JD62B400		JD62T400

2-Pole 600V AC, 250V DC (3-Pole Width)

200	JD62B200■	JD62F400	JD62T200■
225	JD62B225■		JD62T225■
250	JD62B250■		JD62T250■
300	JD62B300■		JD62T300■
350	JD62B350■		JD62T350■
400	JD62B400		JD62T400

3-Pole 600V AC, 500V DC^②

200	JD63B200	JD63F400	JD63T200
225	JD63B225		JD63T225
250	JD63B250		JD63T250
300	JD63B300		JD63T300
350	JD63B350		JD63T350
400	JD63B400		JD63T400

Interrupting Ratings

Breaker Type	RMS Symmetrical Amperes (KA)									
	UL 489 AIR (File E10848)					IEC 947-2				
	Volts AC (50/60Hz)			Volts DC		Volts AC (50/60Hz)				
	240	480	600	250	500 ^⑥	220/240		380/415		500
	Icu	Ics	Icu	Ics	Icu	Ics	Icu	Ics	Icu	Ics
JXD2-A	65	—	—	30 (2-P)	—	—	—	—	—	—
JXD6-A, JD6-A	65	35	25	30 (2-P)	25 (3-P)	65	33	40	20	—
HJD6-A, HJXD6-A	100	65	35	30 (2-P)	35 (3-P)	100	50	65	33	—
HHJD6, HHJXD6 ^⑥	200	100	50	—	—	—	—	—	—	—
CJD6-A	200	150	100	30 (2-P)	50 (3-P)	—	—	—	—	—

Instantaneous Adjustment Trip Range

Breaker Ampere Rating	Nominal Instantaneous Values							
	±20% Tolerance Low	2	3	4	5	6	7	±20% Tolerance High
200-300	1250	1430	1610	1790	1960	2140	2320	2500
350-400	2000	2290	2570	2860	3140	3430	3710	4000

■ Built to order. Allow 2-3 weeks for delivery.

①Type JXD2 and JXD6 circuit breakers are UL Listed for reverse feed applications.

⑤When wired as shown on page 17/5, this circuit breaker is UL listed and rated for use on 500V DC ungrounded UPS systems only.

⑥See Note: A, page 17/101

⑥HHJD6 type circuit breakers meet the UL criteria for "current limiting" at 240 and 480V AC.

⑥HACR rated.

Note: JD frame qualified to UL489 supplement B "NAVAL." See page 17/104 for additional information.

Ordering Information

Complete Breaker Unassembled with Lugs

Prices of JD6, HJD6, and HHJD6 breakers include frame, trip and both line and load lugs (TA2J6500). When ordered by these catalog numbers, the customer will receive the frame, trip, and lugs separately packaged. For applications requiring different lugs, order individual items as needed.

Complete Breaker Assembled with Lugs

Prices of JXD6, HJXD6, HHJXD6, and CJD6 include frame with non-interchangeable trip unit installed only. Order required lugs separately. For line and load lugs (TA2J6500) installed, add suffix "L" to catalog number (add 2 times list price of lugs for each pole).

100% Rated (3-pole only)

Types JXD6 and HJXD6 breakers are available with 100% ratings. To order add suffix "H" to catalog number, and 10% to list price.■

100% rated JD breakers require the use of 90°C Cu cable sized at 75°C ampacity and lugs TC1J6600 or TC2J6500.

50°C Applications see page 17/104.

400Hz Applications see page 17/104.

Lugs For 75°C Wire^③

Catalog Number	Cables per Lug	Wire Range
TA2J6500	1, 2	#3/0-500 kcmil Cu #4/0-500 kcmil Al
TA1L6750	1	500-750 kcmil Al 500-600 kcmil Cu
TC1J6600	1	#3/0-600 kcmil Cu
TC2J6500	1, 2	#3/0-500 kcmil Cu
Compression Lug		
CCL600	1	500 kcmil Cu/Al

Modifications page 17/104

Accessories pages 17/72 and 17/108 to 17/113

Sentron Molded Case Circuit Breakers

JD 400A Frame Sentron Series

Selection/Dimensions

Type HJD6-A, HJXD6-A^{②④⑥}

Black Label

Interchangeable Trip			
Continuous Current Rating @ 40°C	Complete Breaker Unassembled w/Lugs	Frame Only	Trip Unit Only
	Catalog Number	Catalog Number	Catalog Number
2-Pole 600V AC, 250V DC (3-Pole Width)			
200	HJD62B200■	HJD62F400■	JD62T200■
225	HJD62B225■		JD62T225■
250	HJD62B250■		JD62T250■
300	HJD62B300■		JD62T300■
350	HJD62B350■		JD62T350■
400	HJD62B400■		JD62T400■

3-Pole 600V AC, 500V DC^{①②⑤}

200	HJD63B200	HJD63F400	JD63T200
225	HJD63B225		JD63T225
250	HJD63B250		JD63T250
300	HJD63B300		JD63T300
350	HJD63B350		JD63T350
400	HJD63B400		JD63T400

Type HHJD6, HHJXD6^{②④⑥}

Black Label

2-Pole 600V AC (3-Pole Width)

200	HHJD62B200■	HHJD62F400■	JD62T200■
225	HHJD62B225■		JD62T225■
250	HHJD62B250■		JD62T250■
300	HHJD62B300■		JD62T300■
350	HHJD62B350■		JD62T350■
400	HHJD62B400■		JD62T400■

3-Pole 600VAC

200	HHJD63B200	HHJD63F400	JD63T200
225	HHJD63B225		JD63T225
250	HHJD63B250		JD63T250
300	HHJD63B300		JD63T300
350	HHJD63B350		JD63T350
400	HHJD63B400		JD63T400

Type CJD6-A^{⑤⑥}

Fuseless Current Limiting

Red Label

Non-Interchangeable Trip (Assembled Circuit Breaker Without Lugs)		
Continuous Current Rating @ 40°C	2-Pole 600V AC/250V DC	3-Pole 600V AC/500V DC
	Catalog Number	Catalog Number
200	For 2-pole application use outside poles of 3-pole circuit breaker	CJD63B200■
225		CJD63B225■
250		CJD63B250■
300		CJD63B300■
350		CJD63B350■
400		CJD63B400■

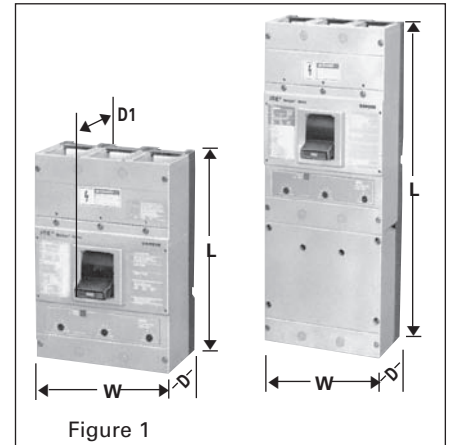

Figure 1

Dimensions (in inches)

Breaker Type	W	L	D	To Handle D1
Figure 1 JXD2-A, JXD6-A, JD6-A HJD6-A, HJXD6-A, HHJD6, HJD6, HJXD6, HHJXD6, JXD6-ETI ^⑧ , SJD6, SHJD6	7.5	11	4	5.44
Figure 2 CJD6, CJD6-ETI ^⑧ , SCJD6	7.5	17.86	4	5.44

Enclosures (Except SCJD6)

Type	Catalog Number
1	J6N1
3R	J6N3R
12	J6N12
4X	LD6SS4
7, 9 (200-250A)	EC4
7, 9 (300-400A)	EE
Neutral	W60992

Shipping Weights

Number of Poles	Number per Carton	Shipping Weight (lbs.)
JXD2, JXD6, JD6, HJD6, HHJD6 Assembled Breaker (less terminals)		
2	1	17.5
3	1	19.5
JD6, HJD6, HHJD6 Frame Only		
2	1	14
3	1	15.5
JD6 Trip Unit Only		
2	1	3.5
3	1	4
CJD6 Complete Assembled Breaker (less terminals)		
3	1	31.5

For inches / millimeters conversion, see Application Data section.

■ Built to order. Allow 2-3 weeks for delivery.

2-pole units available in 3-pole construction.

① When wired as shown on page 17/5, this circuit breaker is UL listed and rated for use on 500V DC ungrounded UPS systems only.

② For non-interchangeable 3-pole HJD6 or HHJD6 type circuit breaker change the prefix identifier to HJXD6 or HHJXD6. Price equals price of frame plus price of trip, e.g. price of HJXD63B400 equals price of HJD63F400 plus price of JD63T400. Order lugs separately.

③ JXD6-ETI, CJD6-ETI see page 17/91 for ordering information.

④ Type HJXD6, HHJXD6 Circuit Breakers are UL listed for reverse fed applications.

⑤ CE applies to non-interchangeable type HJXD6-A only.

⑥ HACR rated.

Sentron Molded Case Circuit Breakers

SJD 400A Frame Digital Solid State Sentron Sensitrip III Series

Selection

Type SJD6-A

Blue Label

3-Pole, 600V AC	
Catalog Number	Max Current Rating
SJD69200■	200
SJD69300■	300
SJD69400■	400
SJD69200G■	200
SJD69300G■	300
SJD69400G■	400
SJD69200NT■	200
SJD69300NT■	300
SJD69400NT■	400
SJD69200NGT■	200
SJD69300NGT■	300
SJD69400NGT■	400

Type SHJD6-A

Black Label

3-Pole, 600V AC	
Catalog Number	Max Current Rating
SHJD69200■	200
SHJD69300■	300
SHJD69400■	400
SHJD69200G■	200
SHJD69300G■	300
SHJD69400G■	400
SHJD69200NT■	200
SHJD69300NT■	300
SHJD69400NT■	400
SHJD69200NGT■	200
SHJD69300NGT■	300
SHJD69400NGT■	400

Current Limiting

Type SCJD6-A

Red Label

3-Pole, 600V AC	
Catalog Number	Max Current Rating
SCJD69200■	200
SCJD69300■	300
SCJD69400■	400
SCJD69200G■	200
SCJD69300G■	300
SCJD69400G■	400
SCJD69200NT■	200
SCJD69300NT■	300
SCJD69400NT■	400
SCJD69200NGT■	200
SCJD69300NGT■	300
SCJD69400NGT■	400

Ordering Information

Pricing information for all Digital Sentron Series SJD frames is for complete breaker only – price required lugs as separate items – lugs are suitable for 75° C wire.

SJD6 and SCJD6 are acceptable for reverse connection application.

SHJD6 are not acceptable for reverse connection application.

Shipping Weights

Breaker Type	Number per Carton	Shipping Weight (lbs)
SJD6-A	1	20
SHJD6-A	1	20
SCJD6-A	1	33

SJD 400A Frame – 100% Rated²

Type SJD6-A

Blue Label

3-Pole, 600V AC	
Catalog Number	Max Current Rating
SJD69200H■	200
SJD69300H■	300
SJD69400H■	400
SJD69200GH■	200
SJD69300GH■	300
SJD69400GH■	400
SJD69200NTH■	200
SJD69300NTH■	300
SJD69400NTH■	400
SJD69200NGTH■	200
SJD69300NGTH■	300
SJD69400NGTH■	400

Type SHJD6-A

Black Label

3-Pole, 600V AC	
Catalog Number	Max Current Rating
SHJD69200H■	200
SHJD69300H■	300
SHJD69400H■	400
SHJD69200GH■	200
SHJD69300GH■	300
SHJD69400GH■	400
SHJD69200NTH■	200
SHJD69300NTH■	300
SHJD69400NTH■	400
SHJD69200NGTH■	200
SHJD69300NGTH■	300
SHJD69400NGTH■	400

Lugs for 75° C Wire¹

Catalog Number	No of Cables per Connector	Wire Range
TA2J6500	2	#3/0-500 kcmil Cu #4/0-500 kcmil Al
TA1L6750	1	500–750 kcmil Al 500–600 kcmil Cu
TC1J6600	1	#3/0-600 kcmil Cu
TC2J6500	2	#3/0-500 kcmil Cu
TA2J630	2	#4-#3/0-Cu/Al
Compression Lug		
CCL600	(1 pc.)	#1/0-500 kcmil Cu/Al

Neutral Transformers

Ampere Rating	Catalog Number
200	N02SJD
300	N03SJD
400	N04SJD

Trip Unit Adjustable Functions

Suffix Letter Code	Trip Type	Cont Current Setting	Long Time Delay	Instantaneous Setting	Short Time Pick Up	Short Time Delay	Short Time I ² t Pick Up	Ground Fault Pick Up	Ground Fault Delay
None	LI	✓	✓	✓					
G	LIG	✓	✓	✓				✓	✓
NT	LSI	✓	✓	✓	✓	✓	✓		
NGT	LSIG	✓	✓	✓	✓	✓	✓	✓	✓

Interrupting Ratings

Breaker Type	RMS Symmetrical kA UL 489 (File E10848)		
	240V AC	480V AC	600V AC
SJD6-A	65	35	25
SHJD6-A	100	65	35
SCJD6-A	200	150	100

Note: "G" suffix in catalog number denotes circuit breaker for 3-phase, 3-wire systems.
For 3-phase, 4-wire, order correct 4th wire (neutral) transformer as separate and additional item.

■ Built to order. Allow 2–3 weeks for delivery.

①For additional information, see **Note: A**, page 17/101.

②Refer to the NEC for proper application of 100% rated devices.

Accessories pages 17-72 and 17/108 to 17/113

Molded Case Circuit Breakers

Internal Accessories

Selections

Accessories for:

JD 400A Frame
LD 600A Frame
LMD 800A Frame
SJD 400A Frame
SLD 600A Frame



Sensitrip Ammeter



The Ammeter Display Units plug into the Sensitrip Trip Unit and displays the phase current flowing in the breaker. They are powered by the breaker's CT's with replaceable battery back-up for maintaining trip and max logs.

The SADU reads currents, current imbalance, current demand, and trip status.

Ammeter Mounting Kit

The Ammeter may also be panel or door mounted using the SADURMK18 remote mounting kit.

Shunt Trip Combinations

Control Voltage		1 Shunt Trip	1 Shunt Trip and 1 Auxiliary Switch
AC	DC	Catalog Number	Catalog Number
24		S17JLD6	—
48		S18JLD6▲	—
120		S01JLD6	S01JLD62A
240		S03JLD6	S03JLD62A
277		S15JLD6▲	S15JLD64A▲
480		S04JLD6	—
	12	S16JLD6▲	S16JLD62A▲
	24	S07JLD6	S07JLD62A
	48	S09JLD6▲	S09JLD62A
	125	S11JLD6	S11JLD62A▲
	250	S13JLD6▲	S13JLD62A▲

Undervoltage Trip Combinations

Control Voltage		1 Undervoltage Trip	1 Undervoltage Trip and 1 Auxiliary Switch	1 Undervoltage Trip and 2 Auxiliary Switches
AC	DC	Catalog Number	Catalog Number	Catalog Number
120		U01JLD6	U01JLD62A	U01JLD62AA
208		U02JLD6▲	U02JLD62A▲	U02JLD62AA▲
240		U03JLD6	U03JLD62A▲	U03JLD62AA▲
480		U06JLD6	U06JLD64A▲	U06JLD64AA▲
	24	U13JLD6	U13JLD62A	U13JLD62AA
	48	U14JLD6▲	U14JLD62A▲	U14JLD62AA▲
	125	U10JLD6▲	U10JLD62A▲	U10JLD62AA▲
	250	U12JLD6▲	U12JLD62A▲	U12JLD62AA▲

Auxiliary Switch Combinations

Maximum Voltage		1 Form C	2 Form C
AC	DC	Catalog Number	Catalog Number
480	250	A01JLD64	A02JLD64
—	12	A01JLDLV	A02JLDLV

Alarm Switch Combinations

Maximum Voltage		1 Alarm Switch	1 Alarm Switch and 1 Auxiliary Switch	1 Alarm Switch and 2 Auxiliary Switches
AC	DC	Catalog Number	Catalog Number	Catalog Number
480	250	B01JLD64	A01JLD64B	A02JLD64B

Plug-in Ammeter Display Units

Breaker Type	Description	Catalog Number
SJD, SLD	Display Unit	SADU
	Remote Mounting Kit	SADURMK18

Note: Accessory modules can only be added to right side pole of solid state SJD and SLD frame circuit breakers. No accessories can be added if mechanical interlock is used. All accessories on this page are useable on superseded JD2, JJ6, JL6, HJ6, SJL, LJ6, LL6, HL6 and SLL circuit breakers.

▲ Built to order. Allow 6–8 weeks for delivery.

Sentron Molded Case Circuit Breakers

LD 600A Frame Sentron Series

Selection

Type LXD6-A ^{①④}		Blue Label	
Non-Interchangeable Trip (Assembled Circuit Breaker without Lugs)			
Continuous Current Rating @ 40°C	2-Pole (3-Pole Width)		3-Pole
	600V AC	250V DC	600V AC 500V DC
	Catalog Number		Catalog Number
450	LXD62B450■		LXD63B450
500	LXD62B500■		LXD63B500
600	LXD62B600		LXD63B600

Type LD6-A ^④		Blue Label	
Interchangeable Trip			
Continuous Current Rating @ 40°C	Complete Breaker Unassembled w/Lugs	Frame Only	Trip Unit Only
	Catalog Number	Catalog Number	Catalog Number

2-Pole 600V AC, 250V DC (3-Pole Width)

Current Rating	Complete Breaker Unassembled w/Lugs	Frame Only	Trip Unit Only
250	LD62B250■	LD62F600	JD62T250■
300	LD62B300■		JD62T300■
350	LD62B350■		JD62T350■
400	LD62B400		JD62T400
450	LD62B450■		LD62T450■
500	LD62B500■		LD62T500■
600	LD62B600		LD62T600

3-Pole 600V AC, 500V DC^②

Current Rating	Complete Breaker Unassembled w/Lugs	Frame Only	Trip Unit Only
250	LD63B250	LD63F600	JD63T250
300	LD63B300		JD63T300
350	LD63B350		JD63T350
400	LD63B400		JD63T400
450	LD63B450		LD63T450
500	LD63B500		LD63T500
600	LD63B600		LD63T600

Interrupting Ratings

Breaker Type	RMS Symmetrical Amperes (KA)										
	UL 489 AIR (File E10848)					IEC 947-2					
	Volts AC (50/60Hz)			Volts DC		Volts AC (50/60Hz)					
	240	480	600	250	500 ^⑤	220/240		380/415		500	
					(Icu)	(Ics)	(Icu)	(Ics)	(Icu)	(Ics)	
LD6-A, LXD6-A	65	35	25	30 (2-P)	25 (3-P)	65	33	40	20	—	—
HLD6-A, HLXD6-A	100	65	35	30 (2-P)	35 (3-P)	100	50	65	33	—	—
HHL6, HHLXD6	200	100	50	—	—	—	—	—	—	—	—
CLD6-A	200	150	100	—	50 (3-P)	—	—	—	—	—	—

Instantaneous Adjustment Trip Range

Breaker Ampere Rating	Nominal Instantaneous Values							
	+20% Tolerance Low	2	3	4	5	6	7	+20% Tolerance High
	250-300	1250	1430	1610	1790	1960	2140	2320
350-450	2000	2290	2570	2860	3140	3430	3710	4000
500-600	3000	3430	3800	4290	4710	5140	5570	6000

■ Built to order. Allow 2-3 weeks for delivery.

① Type LXD6A circuit breakers are UL Listed for reverse fed applications.

② When wired as shown on page 17/5, this circuit breaker is UL listed and rated for use on 500V DC ungrounded UPS systems only.

③ See Note: A, page 17/101.

④ HACR rated.

Note: LD frame qualified to UL489 supplement SB "NAVAL". See page 17/104 for additional information.

Modifications page 17/104
Accessories pages 17/76 and 17/108 to 17/113

Ordering Information

Complete Breaker Unassembled with Lugs

Prices of LD6, HLD6, and HHL6 breakers include frame, trip, and both line and load lugs (TA2J6500). When ordered by these catalog numbers, the customer will receive the frame, trip and lugs separately packaged. For applications requiring different lugs, order individual items as needed.

Complete Breaker Assembled without Lugs

Prices of LXD6, HLXD6, HHLXD6, and CLD6 include frame with non-interchangeable trip unit installed only. Order required lugs separately. For line and load lugs (TA2J6500) installed, add suffix "L" to catalog number (add 2 times list price of lugs for each pole).

100% Rated (3-pole only)

Types LXD6 and HLXD6 breakers are available with 100% ratings. To order add suffix "H" to catalog number, and 10% to list price. 100% rated LD breakers require the use of 90°C Cu cable sized at 75°C ampacity and lugs TC1J6600 or TC2J6500.

50°C Applications see page 17/104.

400Hz Applications see page 17/104.

Shipping Weights

Number of Poles	Number per Carton	Shipping Weight (lbs.)
LXD6, LD6, HLD6, HHL6 Assembled Breaker (less terminals)		
2	1	17.5
3	1	19.5
LD6, HLD6, HHL6 Frame Only		
2	1	14
3	1	15.5
LD6, HHL6 Trip Unit Only		
2	1	3.5
3	1	4
CLD6 Complete Assembled Breaker (less terminals)		
3	1	31.5

Lugs For 75°C Wire^③

Catalog Number	Cables per Lug	Wire Range
TA2J6500	1, 2	#3/0 500 kcmil Cu #4/0 500 kcmil Al
TC2J6500	2	#3/0-500 kcmil Cu
TA1L6750	1	500-750 kcmil Al 500-600 kcmil Cu
TC1J6600	1	#3/0-600 kcmil Cu
Compression Lug		
CCL600	1	500 kcmil Cu/Al

Sentron Molded Case Circuit Breakers

LD 600A Frame Sentron Series

Selection/Dimensions

Type HLD6-A, HLXD6-A^{②③④}

Black Label

Interchangeable Trip			
Continuous Current Rating @ 40°C	Complete Breaker Unassembled w/Lugs	Frame Only	Trip Unit Only
	Catalog Number	Catalog Number	Catalog Number
2-Pole 600V AC, 250V DC (3-Pole Width)			
250	HLD62B250■	HLD62F600■	JD62T250■
300	HLD62B300■		JD62T300■
350	HLD62B350■		JD62T350■
400	HLD62B400■		JD62T400■
450	HLD62B450■		LD62T450■
500	HLD62B500■		LD62T500■
600	HLD62B600■		LD62T600■

3-Pole 600V AC, 500V DC^{①⑤}

250	HLD63B250■	HLD63F600	JD63T250
300	HLD63B300■		JD63T300
350	HLD63B350■		JD63T350
400	HLD63B400■		JD63T400
450	HLD63B450■		LD63T450
500	HLD63B500■		LD63T500
600	HLD63B600■		LD63T600

Type HHL6, HHLXD6^{②③④}

Black Label

2-Pole 600V AC (3-Pole Width)

250	HHL62B250■	HHL62F600■	JD62T250■
300	HHL62B300■		JD62T300■
350	HHL62B350■		JD62T350■
400	HHL62B400■		JD62T400■
450	HHL62B450■		HHL62T450■
500	HHL62B500■		HHL62T500■
600	HHL62B600■		HHL62T600■

3-Pole 600V AC

250	HHL63B250■	HHL63F600	JD63T250
300	HHL63B300■		JD63T300
350	HHL63B350■		JD63T350
400	HHL63B400■		JD63T400
450	HHL63B450■		HHL63T450■
500	HHL63B500■		HHL63T500■
600	HHL63B600■		HHL63T600■

Type CLD6-A^{③④}

Fuseless Current Limiting

Red Label

Non-Interchangeable Trip (Assembled Circuit Breaker Without Lugs)		
Continuous Current Rating @ 40°C	2-Pole 600V AC/250V DC	3-Pole 600V AC/500V DC
	Catalog Number	Catalog Number
450	For 2-pole application use outside poles of 3-pole circuit breaker	CLD63B450■
500		CLD63B500
600		CLD63B600

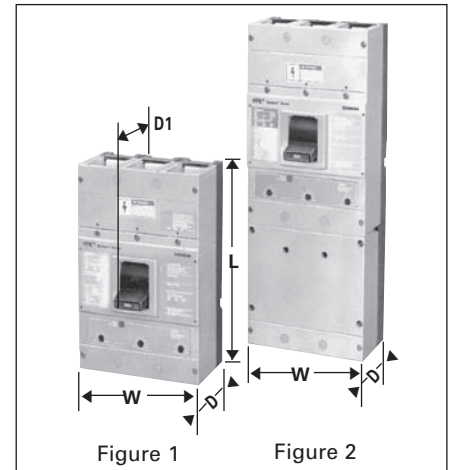

Dimensions (in inches)

Breaker Type	W	L	D	To Handle D1
Figure 1 LXD6-A, LD6-A HLD6-A HHL6, HHLXD6, LXD6-ETI ^⑥ , SLD6, SHLD6	7.5	11	4	5.44
Figure 2 CLD6, CLD6-ETI ^⑥ , SCLD6	7.5	17.86	4	5.44

Enclosures: (except SCLD6)

Type	Catalog Number
1	LD6N1
3R	LD6N3R
12	LD6N12
4X	LD6SS4
7,9	ED6
Neutral	W60993

For inches / millimeters conversion, see Application Data section.

■ Built to order. Allow 2-3 weeks for delivery.

① When wired as shown on page 17/5, this circuit breaker is UL listed and rated for use on 500V DC ungrounded UPS systems only.

② For complete assembled 3-pole HLD6 or HHL6 type circuit breaker change the prefix identifier HLD6 or HHL6 to HLXD6 or HHLXD6. Price is sum of frame and trip units prices, e.g. price of HLXD63B400 is the price of HLD63F600 plus the price of LD63T600. Order the terminal connectors separately.

③ Type HLXD6, HHLXD6, & CLD6 Circuit Breakers are UL Listed for reverse feed applications.
④ LXD6-ETI, CLD6-ETI see page 17/91 for ordering information.
⑤ CE Applies to non-interchangeable type HLXD only.
⑥ HACR rated.

Sentron Molded Case Circuit Breakers

SLD 600A Frame Digital Solid State Sentron Sensitrip III Series

Selection

Type SLD6-A

Blue Label

3-Pole, 600V AC	
Catalog Number	Max Current Rating
SLD69300■	300
SLD69400■	400
SLD69500■	500
SLD69600■	600
SLD69300G■	300
SLD69400G■	400
SLD69500G■	500
SLD69600G■	600
SLD69300NT■	300
SLD69400NT■	400
SLD69500NT■	500
SLD69600NT■	600
SLD69300NGT■	300
SLD69400NGT■	400
SLD69500NGT■	500
SLD69600NGT■	600

Type SHLD6-A

Black Label

3-Pole, 600V AC	
Catalog Number	Max Current Rating
SHLD69300■	300
SHLD69400■	400
SHLD69500■	500
SHLD69600■	600
SHLD69300G■	300
SHLD69400G■	400
SHLD69500G■	500
SHLD69600G■	600
SHLD69300NT■	300
SHLD69400NT■	400
SHLD69500NT■	500
SHLD69600NT■	600
SHLD69300NGT■	300
SHLD69400NGT■	400
SHLD69500NGT■	500
SHLD69600NGT■	600

Current Limiting

Type SCLD6-A

Red Label

3-Pole, 600V AC	
Catalog Number	Max Current Rating
SCLD69300■	300
SCLD69400■	400
SCLD69500■	500
SCLD69600■	600
SCLD69300G■	300
SCLD69400G■	400
SCLD69500G■	500
SCLD69600G■	600
SCLD69300NT■	300
SCLD69400NT■	400
SCLD69500NT■	500
SCLD69600NT■	600
SCLD69300NGT■	300
SCLD69400NGT■	400
SCLD69500NGT■	500
SCLD69600NGT■	600

Ordering Information

Pricing information for all Digital Sentron Series SLD frames is for complete breaker only – price required lugs as separate items – lugs are suitable for 75° C wire.

SLD6 and SCLD6 are suitable for reverse connection application.
SHLD6 are not suitable for reverse connection application.

Shipping Weights

Breaker Type	Number per Carton	Shipping Weight (lbs)
SLD6-A	1	20
SHLD6-A	1	20
SCLD6-A	1	33

Neutral Transformers

Ampere Rating	Catalog Number
300	N03SJD
400	N04SJD
500	N05SLD
600	N06SLD

Trip Unit Adjustable Functions

Suffix Letter Code	Trip Type	Cont Current Setting	Long Time Delay	Instantaneous Setting	Short Time Pick Up	Short Time Delay	Short Time I ² t Pick Up	Ground Fault Pick Up	Ground Fault Delay
None	LI	✓	✓	✓					
G	LIG	✓	✓	✓				✓	✓
NT	LSI	✓	✓	✓	✓	✓	✓		
NGT	LSIG	✓	✓	✓	✓	✓	✓	✓	✓

Interrupting Ratings

Breaker Type	RMS Symmetrical kA UL 489 (File E10848)		
	240V AC	480V AC	600V AC
SLD6-A	65	35	25
SHLD6-A	100	65	35
SCLD6-A	200	150	100

Note: "G" suffix in catalog number denotes circuit breaker for 3-phase, 3-wire circuits.
 For 3-phase, 4-wire, order correct 4th wire (neutral) transformer as separate and additional item.

For ordering information and terminal connectors see page 17/73; for enclosures, see page 17/74.

100% Rated – Not available in SLD6 Frame.

■ Built to order. Allow 2–3 weeks for delivery.

Molded Case Circuit Breakers

Internal Accessories

Selection

Accessories for:

JD 400A Frame
LD 600A Frame
LMD 800A Frame
SJD 400A Frame
SLD 600A Frame



Sensitrip Ammeter



The Ammeter Display Units plug into the Sensitrip Trip Unit and displays the phase current flowing in the breaker. They are powered by the breaker's CT's with replaceable battery back-up for maintaining trip and max logs.

The SADU reads currents, current imbalance, current demand, and trip status.

Ammeter Mounting Kit

The Ammeter may also be panel or door mounted using the SADURMK18 remote mounting kit.

Shunt Trip Combinations

Control Voltage		1 Shunt Trip	1 Shunt Trip and 1 Auxiliary Switch
AC	DC	Catalog Number	Catalog Number
24		S17JLD6	—
48		S18JLD6▲	—
120		S01JLD6	S01JLD62A
240		S03JLD6	S03JLD62A
277		S15JLD6▲	S15JLD64A▲
480		S04JLD6	—
	12	S16JLD6▲	S16JLD62A▲
	24	S07JLD6	S07JLD62A
	48	S09JLD6▲	S09JLD62A
	125	S11JLD6	S11JLD62A▲
	250	S13JLD6▲	S13JLD62A▲

Undervoltage Trip Combinations

Control Voltage		1 Undervoltage Trip	1 Undervoltage Trip and 1 Auxiliary Switch	1 Undervoltage Trip and 2 Auxiliary Switches
AC	DC	Catalog Number	Catalog Number	Catalog Number
120		U01JLD6	U01JLD62A	U01JLD62AA
208		U02JLD6▲	U02JLD62A▲	U02JLD62AA▲
240		U03JLD6	U03JLD62A▲	U03JLD62AA▲
480		U06JLD6	U06JLD64A▲	U06JLD64AA▲
	24	U13JLD6	U13JLD62A	U13JLD62AA
	48	U14JLD6▲	U14JLD62A▲	U14JLD62AA▲
	125	U10JLD6▲	U10JLD62A▲	U10JLD62AA▲
	250	U12JLD6▲	U12JLD62A▲	U12JLD62AA▲

Auxiliary Switch Combinations

Maximum Voltage		1 Form C	2 Form C
AC	DC	Catalog Number	Catalog Number
480	250	A01JLD64	A02JLD64
—	12	A01JLDLV	A02JLDLV

Alarm Switch Combinations

Maximum Voltage		1 Alarm Switch	1 Alarm Switch and 1 Auxiliary Switch	1 Alarm Switch and 2 Auxiliary Switches
AC	DC	Catalog Number	Catalog Number	Catalog Number
480	250	B01JLD64	A01JLD64B	A02JLD64B

Plug-in Ammeter Display Units

Breaker Type	Description	Catalog Number
SJD, SLD	Display Unit	SADU
	Remote Mounting Kit	SADURMK18

Note: Accessory modules can only be added to right side pole of solid state SJD and SLD frame circuit breakers. No accessories can be added if mechanical interlock is used. All accessories on this page are useable on superseded JD2, JJ6, JL6, HJ6, SJL, LJ6, LL6, HL6 and SLL circuit breakers.

▲ Built to order. Allow 6–8 weeks for delivery.

Sentron Molded Case Circuit Breakers

LMD 800A Frame Sentron Series

Selection/Dimensions

Type LMXD6^{①④}

Blue Label

Non-Interchangeable Trip (Assembled Circuit Breaker without Lugs)		
Continuous Current Rating @ 40°C	2-Pole (3-Pole Width) Catalog Number	3-Pole Catalog Number
500	—	LMXD63B500■
600	LMXD62B600■	LMXD63B600
700	LMXD62B700■	LMXD63B700
800	LMXD62B800	LMXD63B800

Type LMD6^④

Blue Label

Interchangeable Trip			
Continuous Current Rating @ 40°C	Complete Breaker Unassembled w/Lugs	Frame Only	Trip Unit Only
	Catalog Number	Catalog Number	Catalog Number

2-Pole 600V AC, 250V DC (3-Pole Width)

500	LMD62B500■	LMD62F800■	LMD62T500■
600	LMD62B600■		LMD62T600■
700	LMD62B700■		LMD62T700■
800	LMD62B800■		LMD62T800■

3-Pole 600V AC, 500V DC^②

500	LMD63B500■	LMD63F800	LMD63T500■
600	LMD63B600■		LMD63T600■
700	LMD63B700■		LMD63T700■
800	LMD63B800		LMD63T800

Instantaneous Adjustment Trip Range

Ampere Rating	Nominal Instantaneous Values							High +/- 20% Tolerance
	Low +/- 20% Tolerance	2	3	4	5	6	7	
500-600	3000	3430	3860	4290	4710	5140	5570	6000
700-800	3200	3500	3700	4200	4700	6400	7300	8000

Ordering Information

Complete Breaker Unassembled with Lugs

Prices of LMD6 and HLMD6 breakers include frame, trip, and both line and load lugs (TA3K500). These catalog numbers include the frame, trip and lugs separately packaged. For applications requiring different lugs, order individual items as needed.

Complete Breaker Assembled without Lugs

Prices of LMXD6 and HLMXD6 include frame with non-interchangeable trip unit installed only. Order required lugs separately. For line and load lugs (TA3K500) installed, add suffix "L" to catalog number (add 2 times list price of lugs for each pole).

50°C Applications see page 17/104.

400Hz Applications see page 17/104.

Shipping Weights

Number of Poles	Number per Carton	Shipping Weight (lbs.)
LMD6, HLMD6, LMXD6, HLMXD6 Complete Breaker (less terminals)		
2	1	53
3	1	61.5
LMD6, HLMD6 Frame Only		
2	1	42.25
3	1	46
LMD6, HLMD6 Trip Unit Only		
2	1	4.5
3	1	6.5

Lugs^③ for 75°C Wire

Catalog Number	Cables per Lug	Wire Range
TA2K500	1, 2	#1-500 kcmil Cu/Al
TA3K500	1-3	#1/0-500 kcmil Cu/Al
TA2N750	1, 2	500-750 kcmil Cu/Al

■ Built to order. Allow 2-3 weeks for delivery.

① LMXD6 circuit breakers are UL Listed for reverse connected applications.

② When wired as shown on page 17-5, this circuit breaker is UL listed and rated for use on 500VDC ungrounded UPS systems only.

③ See **Note: A**, page 17/101.

④ HACR rated.

Modifications page 17/104
Accessories pages 17/79 and 17/108 to 17/113

Sentron Molded Case Circuit Breakers

LMD 800A Frame Sentron Series

Selection/Dimensions

Type HLMXD6 ^{①④}		Black Label
Non-Interchangeable Trip (Assembled Circuit Breaker Without Lugs)		
Continuous Current Rating @ 40°C	2-Pole 600V AC/250V DC	3-Pole 600V AC/500V DC
	Catalog Number	Catalog Number
500	For 2-pole application use outside poles of 3-pole circuit breaker	HLMXD63B500■
600		HLMXD63B600■
700		HLMXD63B700■
800		HLMXD63B800

Type HLMD6 ^④			Black Label
Interchangeable Trip			
Continuous Current Rating @ 40°C	Complete Breaker Unassembled	Frame Only	Trip Unit Only
	Catalog Number	Catalog Number	Catalog Number
2-Pole 600V AC, 250V DC (3-Pole Width)			
500	HLMD62B500■	HLMD62F800■	LMD62T500■
600	HLMD62B600■		LMD62T600■
700	HLMD62B700■		LMD62T700■
800	HLMD62B800■		LMD62T800■
3-Pole 600V AC, 500V DC^③			
500	HLMD63B500	HLMD63F800	LMD63T500■
600	HLMD63B600		LMD63T600■
700	HLMD63B700		LMD63T700■
800	HLMD63B800		LMD63T800

Interrupting Ratings

Breaker Type	UL 489A IR				
	RMS Symmetrical Amperes (KA)				
	Volts AC			Volts DC	
	240	480	600	250	500 ^④
LMD6, LMXD6	65	50	25	30 (2-P)	25 (3-P)
HLMD6, HLMXD6	100	65	50	30 (2-P)	50 (3-P)

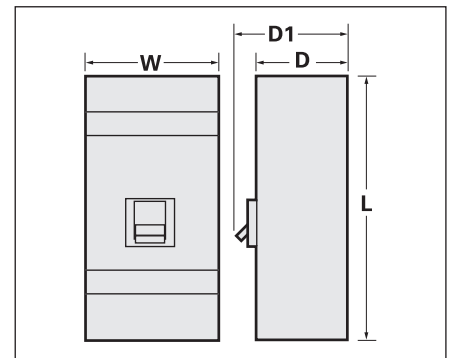
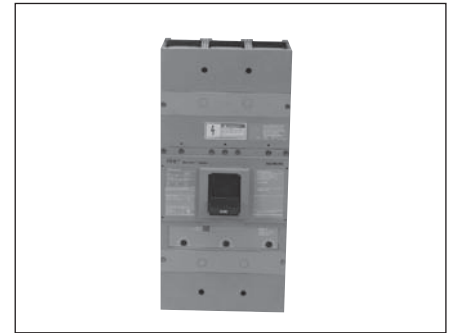

Dimensions (in inches)

Breaker Type	W	L	D	D1
LMD6, LMXD6, HLMD6, HLMXD6, LMXD6-ETI ^②	7.5	16	4.5	5.93

Enclosures

Type	Catalog Number
1	LMD1
3R	LMD3R
12	LMD12■
Neutral	W63623

For inches / millimeters conversion, see Application Data section.

■ Built to order. Allow 2–3 weeks for delivery.

①HLMXD6 circuit breakers are UL Listed for reverse connection applications.

②LMXD6-ETI, see page 17/91 for catalog information.

③ When wired as shown on page 17/5, this circuit breaker is UL listed and rated for use on 500VDC ungrounded UPS systems only.

④ HACR rated.

Accessories for:

JD 400A Frame
LD 600A Frame
LMD 800A Frame
SJD 400A Frame
SLD 600A Frame



Sensitrip Ammeter



The Ammeter Display Units plug into the Sensitrip Trip Unit and displays the phase current flowing in the breaker. They are powered by the breaker's CT's with replaceable battery back-up for maintaining trip and max logs.

The SADU reads currents, current imbalance, current demand, and trip status.

Ammeter Mounting Kit

The Ammeter may also be panel or door mounted using the SADURMK18 remote mounting kit.

Shunt Trip Combinations

Control Voltage		1 Shunt Trip	1 Shunt Trip and 1 Auxiliary Switch
AC	DC	Catalog Number	Catalog Number
24		S17JLD6	—
48		S18JLD6▲	—
120		S01JLD6	S01JLD62A
240		S03JLD6	S03JLD62A
277		S15JLD6▲	S15JLD64A▲
480		S04JLD6	—
	12	S16JLD6▲	S16JLD62A▲
	24	S07JLD6	S07JLD62A
	48	S09JLD6▲	S09JLD62A
	125	S11JLD6	S11JLD62A▲
	250	S13JLD6▲	S13JLD62A▲

Undervoltage Trip Combinations

Control Voltage		1 Undervoltage Trip	1 Undervoltage Trip and 1 Auxiliary Switch	1 Undervoltage Trip and 2 Auxiliary Switches
AC	DC	Catalog Number	Catalog Number	Catalog Number
120		U01JLD6	U01JLD62A	U01JLD62AA
208		U02JLD6▲	U02JLD62A▲	U02JLD62AA▲
240		U03JLD6	U03JLD62A▲	U03JLD62AA▲
480		U06JLD6	U06JLD64A▲	U06JLD64AA▲
	24	U13JLD6	U13JLD62A	U13JLD62AA
	48	U14JLD6▲	U14JLD62A▲	U14JLD62AA▲
	125	U10JLD6▲	U10JLD62A▲	U10JLD62AA▲
	250	U12JLD6▲	U12JLD62A▲	U12JLD62AA▲

Auxiliary Switch Combinations

Maximum Voltage		1 Form C	2 Form C
AC	DC	Catalog Number	Catalog Number
480	250	A01JLD64	A02JLD64
—	12	A01JLDLV	A02JLDLV

Alarm Switch Combinations

Maximum Voltage		1 Alarm Switch	1 Alarm Switch and 1 Auxiliary Switch	1 Alarm Switch and 2 Auxiliary Switches
AC	DC	Catalog Number	Catalog Number	Catalog Number
480	250	B01JLD64	A01JLD64B	A02JLD64B

Plug-in Ammeter Display Units

Breaker Type	Description	Catalog Number
SJD, SLD	Display Unit	SADU
	Remote Mounting Kit	SADURMK18

Note: Accessory modules can only be added to right side pole of solid state SJD and SLD frame circuit breakers. No accessories can be added if mechanical interlock is used. All accessories on this page are useable on superseded JD2, JJ6, JL6, HJ6, SJL, LJ6, LL6, HL6 and SLL circuit breakers.

▲ Built to order. Allow 6–8 weeks for delivery.

Sentron Molded Case Circuit Breakers

MD 800A Frame Sentron Series

Selection

Type MXD6 ^{①⑥}		Blue Label
Non-Interchangeable Trip (Assembled Circuit Breaker Without Lugs)		
Continuous Current Rating @ 40°C	2-Pole ^②	3-Pole
	Catalog Number	Catalog Number
600	MXD62B600■	MXD63B600
700	MXD62B700■	MXD63B700
800	MXD62B800■	MXD63B800

Type MD6 ^⑥			Blue Label
Interchangeable Trip			
Continuous Current Rating @ 40°C	Complete Breaker Unassembled with Lugs	Frame Only	Trip Unit Only
	Catalog Number	Catalog Number	Catalog Number

2-Pole 600V AC, 250V DC^②

Continuous Current Rating @ 40°C	Complete Breaker Unassembled with Lugs	Frame Only	Trip Unit Only
500	MD62B500■	MD62F800■	MD62T500■
600	MD62B600■		MD62T600■
700	MD62B700■		MD62T700■
800	MD62B800■		MD62T800■

3-Pole 600V AC, 500V DC^③

Continuous Current Rating @ 40°C	Complete Breaker Unassembled with Lugs	Frame Only	Trip Unit Only
500	MD63B500	MD63F800	MD63T500
600	MD63B600		MD63T600
700	MD63B700		MD63T700
800	MD63B800		MD63T800

Lugs^④

Catalog Number	Cables Per Lug	Lugs Per Kit	Wire Range
TA2K500	1-2	1	#1-500 kcmil Cu/Al
TA3K500	1-3	1	1/0-500 kcmil Cu/Al
TC2K500	1-2	1	#1-500 kcmil Cu
TC3K350	1-3	1	#1-350 kcmil Cu
Kits			
2TA2N8750 3TA2N8750	1-2	2 3	500-750 kcmil Cu/Al
2TA3N8750 3TA3N8750	1-3	2 3	500-750 kcmil Cu/Al
2TA4N8500 3TA4N8500	1-4	2 3	250-500 kcmil Cu/Al
2TA4P8500 3TA4P8500	1-4	2 3	250-500 kcmil Cu/Al

Instantaneous Adjustment Trip Range

Ampere Rating	Nominal Instantaneous Values							
	Low +/- 20% Tolerance	2	3	4	5	6	7	High +/- 20% Tolerance
500	3000	3430	3860	4280	4710	5140	5570	6000
600-800	4000	4570	5140	5710	6280	6850	7420	8000

■ Built to order. Allow 2-3 weeks for delivery.

①MXD6 circuit breakers are UL Listed for reverse connection applications.

②2-pole units available in 3-pole width only.

③ When wired as shown on page 17/5, this circuit breaker is UL listed and rated for use on 500V DC ungrounded UPS systems.

④ See **Note: A**, page 17/101.

⑤ 80% rated breakers with the CE mark will also be marked in the 100% rated version.

⑥ HACR rated.

Note: MD frame qualified to UL489 supplement B "NAVAL". See page 17/104 for additional information.

Ordering Information

Complete Breaker Unassembled with Lugs

Pricing information for MD6 and HMD6 breakers includes frame, trip, and both line and load lugs (TA3K500). When ordered by these catalog numbers, the customer will receive the frame, trip and lugs separately packaged. For applications requiring different lugs, order individual items as needed.

Complete Breaker Assembled without Lugs

Prices of MXD6, HMXD6 and CMD6 include frame with non-interchangeable trip units installed only. Order required lugs separately. For line and load lugs (TA3K500) installed, add suffix "L" to catalog number (add 2 times list price of lugs for each pole).

100% Rated^⑤

Types MXD6, HMXD6 and CMD6 breakers are available with 100% ratings. To order add suffix "H" to catalog number, and 10% to list price. 100% rated MD breakers require the use of 90°C Cu cable sized at 75°C ampacity and lugs 3TA4P8500 or 3TA2N8750.

50°C Applications see page 17/104.

400Hz Applications see page 17/104.

Shipping Weights

Number of Poles	Number per Carton	Shipping Weight (lbs.)
MD6, HMD6, HMXD6, CMD6 Complete Breaker Assembled (less lugs)		
2	1	53
3	1	61.5
MD6, HMD6 Frame Only		
2	1	42.25
3	1	46
MD6, HMD6 Trip Unit Only		
2	1	4.5
3	1	6.5

Enclosures

Type	Catalog Number
1	MND61
3R	MND63
12	MND612■
Neutral	W63623

Modifications page 17/104

Accessories pages 17/79 and 17/108 to 17/113

Sentron Molded Case Circuit Breakers

MD 800A Frame Sentron Series

Selection/Dimensions

Type HMXD6 ^{①⑤}		Black Label
Non-Interchangeable Trip (Assembled Circuit Breaker Without Lugs)		
Continuous Current Rating @ 40°C	2-Pole 600V AC/250V DC	3-Pole 600V AC/500V DC
	Catalog Number	Catalog Number
600	For 2-pole application use outside poles of 3-pole circuit breaker	HMXD63B600■
700		HMXD63B700■
800		HMXD63B800

Type HMD6 ^⑤		Black Label	
Interchangeable Trip			
Continuous Current Rating @ 40°C	Complete Breaker Unassembled w/Lugs	Frame Only	Trip Unit Only
	Catalog Number	Catalog Number	Catalog Number

2-Pole 600V AC, 250V DC ^②			
500	HMD62B500■	HMD62F800■	MD62T500■
600	HMD62B600■		MD62T600■
700	HMD62B700■		MD62T700■
800	HMD62B800■		MD62T800■

3-Pole 600V AC, 500V DC ^④			
500	HMD63B500	HMD63F800	MD63T500
600	HMD63B600		MD63T600
700	HMD63B700		MD63T700
800	HMD63B800		MD63T800

Type CMD6 ^{①⑤}		Red Label
Fuseless Current Limiting		
Non-Interchangeable Trip (Assembled Circuit Breaker Without Lugs)		
Continuous Current Rating @ 40°C	2-Pole 600V AC/250V DC	3-Pole 600V AC/500V DC
	Catalog Number	Catalog Number
600	For 2-pole application use outside poles of 3-pole circuit breaker	CMD63B600■
700		CMD63B700■
800		CMD63B800

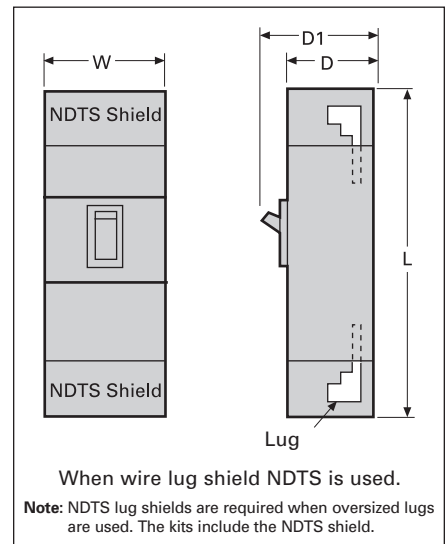

Interrupting Ratings

Breaker Type	UL 489 AIR—File E10848					IEC 947-2 AIR					
	RMS Symmetrical Amperes (KA)					Volts AC (50/60HZ)					
	Volts AC			Volts DC		220/240		380/415		500	
	240	480	600	250	500 ^③	(Icu)	(Ics)	(Icu)	(Ics)	(Icu)	(Ics)
MD6, MXD6	65	50	25	30 (2-P)	25 (3-P)	65	33	40	20	—	—
HMD6, HMXD6	100	65	50	30 (2-P)	50 (3-P)	100	50	65	33	—	—
CMD6	200	100	65	—	50 (3-P)	—	—	—	—	—	—

Dimensions (in inches)

Breaker Type	W	L	D	(To Handle) D1
MD6, MXD6, HMD6, HMXD6, CMD6, MXD6-ETI, CMD6-ETI, SMD6, SHMD6, and SCMD6	9	16	6	8.25
with lug shields	9	24	6	8.25

For inches / millimeters conversion, see Application Data section.

■ Built to order. Allow 2–3 weeks for delivery.

①HMXD6 and CMD circuit breakers are UL listed for reverse connection applications.

②2-pole units available in 3-pole width only.

③MXD6-ETI, CMD6-ETI see page 17/91 for catalog information.

④When wired as shown on page 17/5, this circuit breaker is UL listed and rated for use on 500V DC ungrounded UPS systems only.

⑤ HACR rated.

Sentron Molded Case Circuit Breakers

SMD 800A Frame Digital Solid State Sentron Sensitrip III Series[®]

Selection

Type SMD6

Blue Label

3-Pole, 600V AC	
Catalog Number	Max Current Rating
SMD69600A■	600
SMD69700A■	700
SMD69800A■	800
SMD69600AG■	600
SMD69700AG■	700
SMD69800AG■	800
SMD69600ANT■	600
SMD69700ANT■	700
SMD69800ANT■	800
SMD69600ANGT■	600
SMD69700ANGT■	700
SMD69800ANGT■	800

Type SHMD6

Black Label

3-Pole, 600V AC	
Catalog Number	Max Current Rating
SHMD69600A■	600
SHMD69700A■	700
SHMD69800A■	800
SHMD69600AG■	600
SHMD69700AG■	700
SHMD69800AG■	800
SHMD69600ANT■	600
SHMD69700ANT■	700
SHMD69800ANT■	800
SHMD69600ANGT■	600
SHMD69700ANGT■	700
SHMD69800ANGT■	800

Current Limiting

Type SCMD6-A

Red Label

3-Pole, 600V AC	
Catalog Number	Max Current Rating
SCMD69600A■	600
SCMD69700A■	700
SCMD69800A■	800
SCMD69600AG■	600
SCMD69700AG■	700
SCMD69800AG■	800
SCMD69600ANT■	600
SCMD69700ANT■	700
SCMD69800ANT■	800
SCMD69600ANGT■	600
SCMD69700ANGT■	700
SCMD69800ANGT■	800

Ordering Information

Pricing information for all Digital Sentron Series MD frames is for complete breaker only. Price requires lugs or lug kits as separate items. Lugs are suitable for 75°C wire or as noted. Connector wire ranges and cavities are established in conjunction with Table 6.1.4.2.1 of UL 489 standards. Choose actual connector for circuit breakers based on customer requirements.

Recommended Terminal Connectors

Breaker Frame	Ampere Rating	Connector or Connector Kit
MD	500–600	TA2K500
MD	700–800	TA3K500

Types SMD6 and SHMD6 are acceptable for reverse connection applications.

SMD 800A Frame – 100% Rated^①

Type SMD6

Blue Label

3-Pole, 600V AC	
Catalog Number	Max Current Rating
SMD69600AH■	600
SMD69700AH■	700
SMD69800AH■	800
SMD69600AGH■	600
SMD69700AGH■	700
SMD69800AGH■	800
SMD69600ANTH■	600
SMD69700ANTH■	700
SMD69800ANTH■	800
SMD69600ANGTH■	600
SMD69700ANGTH■	700
SMD69800ANGTH■	800

Type SHMD6

Black Label

3-Pole, 600V AC	
Catalog Number	Max Current Rating
SHMD69600AH■	600
SHMD69700AH■	700
SHMD69800AH■	800
SHMD69600AGH■	600
SHMD69700AGH■	700
SHMD69800AGH■	800
SHMD69600ANTH■	600
SHMD69700ANTH■	700
SHMD69800ANTH■	800
SHMD69600ANGTH■	600
SHMD69700ANGTH■	700
SHMD69800ANGTH■	800

Current Limiting

Type SCMD6-A

Red Label

3-Pole, 600V AC	
Catalog Number	Max Current Rating
SCMD69600AH■	600
SCMD69700AH■	700
SCMD69800AH■	800
SCMD69600AGH■	600
SCMD69700AGH■	700
SCMD69800AGH■	800
SCMD69600ANTH■	600
SCMD69700ANTH■	700
SCMD69800ANTH■	800
SCMD69600ANGTH■	600
SCMD69700ANGTH■	700
SCMD69800ANGTH■	800

Shipping Weights

Breaker Type	Number per Carton	Shipping Weight (lbs)
All types	1	61.5

Lugs for 75°C Wire^②

Catalog Number	Cables per Lug	Wire Range
TA2K500	2	#1–500 kcmil Cu/Al
TA3K500	3	#1–500 kcmil Cu/Al
TC2K500	2	#1–500 kcmil Cu
TC3K350	3	#1–350 kcmil Cu

Kits (3 lugs/kit)

Catalog Number	Cables per Lug	Wire Range
3TA4N8500	4	250–500 kcmil Cu/Al
3TA4P8500	4	250–500 kcmil Cu/Al
3TA2N8750	2	500–750 kcmil Cu/Al
3TA3N8750	3	500–750 kcmil Cu/Al

Each kit contains the following:
 3TA4P8500—3 connectors plus 1 NDS end barrier
 3TA3N8750—3 connectors plus 1 NDS end barrier
 3TA2N8750—3 connectors plus 1 NDS end barrier

Trip Unit Adjustable Functions

Suffix Letter Code	Trip Type	Cont Current Setting	Long Time Delay	Instantaneous Setting	Short Time Pick Up	Short Time Delay	Ground Fault Pick Up	Ground Fault Delay
A	LI	✓	✓	✓				
AG	LIG	✓	✓	✓			✓	✓
ANT	LSI	✓	✓	✓	✓	✓		
ANGT	LSIG	✓	✓	✓	✓	✓	✓	✓

Neutral Transformers

Ampere Rating	Catalog Number
600	N06SMDA
700	N07SMDA
800	N08SMDA

Enclosures

Type	Catalog Number
1	MND61
3R	MND63
12	MND612
Neutral	W63623

Interrupting Ratings

Breaker Type	RMS Symmetrical kA UL 489 (File E10848)		
	240V AC	480V AC	600V AC
SMD6	65	50	25
SHMD6	100	65	50
SCMD6	200	100	65

Note: “G” suffix in catalog number denotes circuit breaker for 3-phase, 3-wire circuits.
 For 3-phase, 4-wire, order correct 4th wire (neutral) transformer as separate and additional item.

■ Built to order. Allow 2–3 weeks for delivery.

① Use 2-3TA4P8500 for 3-pole. These kits are rated for 90°C wire. 90°C Cu only cable must be used, and sized per 75°C ampacity.

② For additional information, see **Note: A**, page 17/101.

③ SMD6, SHMD6 and SCMD6 circuit breakers are UL Listed for reverse connection applications.

Accessories pages 17/90 and 17/108 to 17/113

Sentron Molded Case Circuit Breakers

ND 1200A Frame Sentron Series

Selection

Type NXD6 ^{①③}		Blue Label
Non-Interchangeable Trip (Assembled Circuit Breaker Without Lugs)		
Continuous Current Rating @ 40°C	2-Pole 600V AC/250V DC	3-Pole 600V AC/500V DC
	Catalog Number	Catalog Number
900	NXD62B900■	NXD63B900
1000	NXD62B100■	NXD63B100
1200	NXD62B120■	NXD63B120

Type ND6 ^⑧			Blue Label
Interchangeable Trip			
Continuous Current Rating @ 40°C	Complete Breaker Unassembled with Lugs	Frame Only	Trip Unit Only
	Catalog Number	Catalog Number	Catalog Number
2-Pole 600V AC, 250V DC^②			
800	ND62B800■	ND62F120	MD62T800■
900	ND62B900■		ND62T900■
1000	ND62B100■		ND62T100■
1200	ND62B120		ND62T120

3-Pole 600V AC, 500V DC^③			
800	ND63B800	ND63F120	MD63T800
900	ND63B900		ND63T900
1000	ND63B100		ND63T100
1200	ND63B120		ND63T120

Interrupting Ratings

Breaker Type	RMS Symmetrical Amperes (KA)										
	UL 489 A IR					IEC 947-2					
	Volts AC			Volts DC		Volts AC (50/60HZ)					
	240	480	600	250	500 ^④	220/240		380/415		500	
						(lcu)	(lcs)	(lcu)	(lcs)	(lcu)	(lcs)
ND6, NXD6	65	50	25	30 (2-P)	25 (3-P)	65	33	40	20	—	—
HND6, HNXD6	100	65	50	30 (2-P)	50 (3-P)	100	50	65	33	—	—
CND6	200	100	65	—	50 (3-P)	—	—	—	—	—	—

Instantaneous Adjustment Trip Range

Breaker Ampere Rating	Nominal Instantaneous Values							
	±20% Tolerance Low	2	3	4	5	6	7	±20% Tolerance High
	800	4000	4570	5140	5710	6280	6850	7420
900-1200	5000	5715	6430	7145	7860	8575	9290	10000

■ Built to order. Allow 2-3 weeks for delivery.

①NXD6 circuit breakers are UL listed for reverse connection applications.

②2-pole units available in 3-pole width only.

③When wired as shown on page 17/5, this circuit breaker is UL listed and rated for use on 500VDC ungrounded UPS systems only.

④Use 2 – 3TA4P8500 kits for 3-pole, or 2 – 2TA4P8500 kits for 2-pole. Rated for 90° C cable. Use for 100% rated breakers.

⑤Use 2 – 3TA4N8500 for 3-pole or 2 – 2TA4N8500 for 2-pole. Rated for 75°C cable.

⑥See **Note: A**, page 17/101.

⑦80% rated breakers with the CE mark will also be marked in the 100% rated version.

⑧HACR rated.

Note: ND frame qualified to UL489 supplement B "NAVAL". See page 17/104 for additional information.

Ordering Information

Complete Breaker Unassembled with Lugs

Prices of ND6 and HND6 breakers include frame, trip, and both line and load lugs (3TA4N8500). These catalog numbers are the frame, trip and lugs separately packaged. For applications requiring different lugs, order individual items as needed.

Complete Breaker Assembled without Lugs

Prices of NXD6, HNXD6, and CND6 include frame with non-interchangeable trip units installed only. Order required terminal connectors separately. For line and load lugs (3TA4N8500) installed, add suffix "L" to catalog number (add 2 times list price of lug kit).

100% Rated (3-Pole only)^⑦

Types NXD6, HNXD6 and CND6 breakers are available with 100% ratings. To order, add suffix "H" to catalog number, and add 10% to list price. 100% rated ND breakers require 90°C Cu cable sized at 75°C ampacity and lug kit 3TA4P8500 or 3TA3N8750.

50°C Applications see page 17/104.

400Hz Applications see page 17/104.

Lugs^⑥

Catalog Number	Cables per Lug	Wire Range
TA2K500	2	#1-500 kcmil Cu/Al
TA3K500	3	#1-500 kcmil Cu/Al
TC2K500	2	#1-500 kcmil Cu
TC3K350	3	#1-350 kcmil Cu

Kits (2 Kits required per breaker)

2TA4P8500 ^④ 3TA4P8500 ^⑤	4	250-500 kcmil Cu/Al
2TA4N8500 ^⑤ 3TA4N8500 ^⑤	4	250-500 kcmil Cu/Al
2TA2N8750 3TA2N8750	2	500-750 kcmil Cu/Al
2TA3N8750 3TA3N8750	3	500-750 kcmil Cu/Al

Enclosures

Type	Catalog Number
1	MND61
3R	MND63
12	MND612■
Neutral	W63623

Modifications page 17/104

Accessories pages 17/86 and 17/108 to 17/113

Sentron Molded Case Circuit Breakers

ND 1200A Frame Sentron Series

Selection/Dimensions

Type HNXD6 ^{①④}		Black Label
Non-Interchangeable Trip (Assembled Circuit Breaker Without Lugs)		
Continuous Current Rating @ 40°C	2-Pole 600V AC/250V DC	3-Pole 600V AC/500V DC
	Catalog Number	Catalog Number
900	For 2-pole application use outside poles of 3-pole circuit breaker	HNXD63B900
1000		HNXD63B100
1200		HNXD63B120

Type HND6 ^④		Black Label	
Interchangeable Trip			
Continuous Current Rating @ 40°C	Complete Breaker Unassembled with Lugs	Frame Only	Trip Unit Only
	Catalog Number	Catalog Number	Catalog Number

2-Pole 600V AC, 250V DC^②

800	For 2-pole application use outside poles of 3-pole circuit breaker
900	
1000	
1200	

3-Pole 600V AC, 500V DC^③

800	HND63B800	HND63F120	MD63T800
900	HND63B900		ND63T900
1000	HND63B100		ND63T100
1200	HND63B120		ND63T120

Type CND6 ^{①④}		Red Label
Fuseless Current Limiting		
Non-Interchangeable Trip (Assembled Circuit Breaker)		
Continuous Current Rating @ 40°C	2-Pole	3-Pole
	Catalog Number	Catalog Number
900	For 2-pole application, use outside poles of 3-pole circuit breaker	CND63B900■
1000		CND63B100
1200		CND63B120

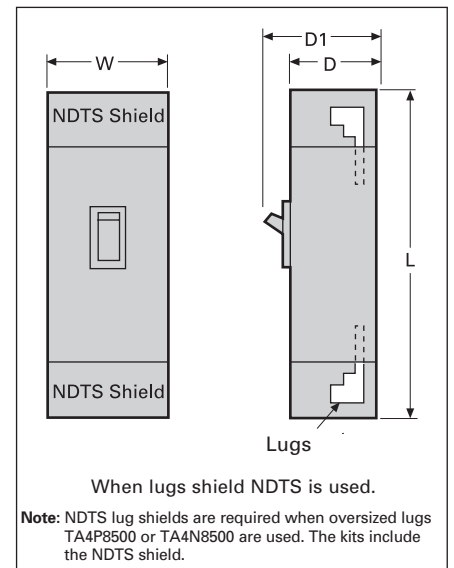

Shipping Weights

Number of Poles	Number per Carton	Shipping Weight (lbs.)
ND6, HND6, NXD6, HNXD6, CND6 Assembled Breaker (less terminals)		
2	1	53
3	1	61.5
ND6, HND6 Frame Only		
2	1	42.25
3	1	46
ND6, HND6 Trip Unit Only		
2	1	4.5
3	1	6.5

Dimensions (in inches)

Breaker Type	W	L	D	D1
ND6, NXD6, HND6, HNXD6, CND6, SND6, SHND6, and SCND6	9	16	6	8.25
with NDTS lug shield	9	24	6	8.25

For inches / millimeters conversion, see Application Data section.

■ Built to order. Allow 2–3 weeks for delivery.

① HNXD6 and CND6 circuit breakers are UL Listed for reverse connection applications.

② 2-pole units available in 3-pole width only.

③ When wired as shown on page 17/5, this circuit breaker is UL listed and rated for use on 500V DC ungrounded UPS systems only.

④ HACR rated.

Sentron Molded Case Circuit Breakers

SND 1200A Frame Digital Solid State Sentron Sensitrip III Series^②

Selection

Type SND6

Blue Label

3-Pole, 600V AC	
Catalog Number	Max Current Rating
SND69800A■	800
SND69100A■	1000
SND69120A■	1200
SND69800AG■	800
SND69100AG■	1000
SND69120AG■	1200
SND69800ANT■	800
SND69100ANT■	1000
SND69120ANT■	1200
SND69800ANGT■	800
SND69100ANGT■	1000
SND69120ANGT■	1200

Type SHND6

Black Label

3-Pole, 600V AC	
Catalog Number	Max Current Rating
SHND69800A■	800
SHND69100A■	1000
SHND69120A■	1200
SHND69800AG■	800
SHND69100AG■	1000
SHND69120AG■	1200
SHND69800ANT■	800
SHND69100ANT■	1000
SHND69120ANT■	1200
SHND69800ANGT■	800
SHND69100ANGT■	1000
SHND69120ANGT■	1200

Current Limiting

Type SCND6-A

Red Label

3-Pole, 600V AC	
Catalog Number	Max Current Rating
SCND69800A■	800
SCND69100A■	1000
SCND69120A■	1200
SCND69800AG■	800
SCND69100AG■	1000
SCND69120AG■	1200
SCND69800ANT■	800
SCND69100ANT■	1000
SCND69120ANT■	1200
SCND69800ANGT■	800
SCND69100ANGT■	1000
SCND69120ANGT■	1200



SND 1200A Frame – 100% Rated^①

Type SND6

Blue Label

3-Pole, 600V AC	
Catalog Number	Max Current Rating
SND69800AH■	800
SND69100AH■	1000
SND69120AH■	1200
SND69800AGH■	800
SND69100AGH■	1000
SND69120AGH■	1200
SND69800ANTH■	800
SND69100ANTH■	1000
SND69120ANTH■	1200
SND69800ANGTH■	800
SND69100ANGTH■	1000
SND69120ANGTH■	1200

Type SHND6

Black Label

3-Pole, 600V AC	
Catalog Number	Max Current Rating
SHND69800AH■	800
SHND69100AH■	1000
SHND69120AH■	1200
SHND69800AGH■	800
SHND69100AGH■	1000
SHND69120AGH■	1200
SHND69800ANTH■	800
SHND69100ANTH■	1000
SHND69120ANTH■	1200
SHND69800ANGTH■	800
SHND69100ANGTH■	1000
SHND69120ANGTH■	1200

Current Limiting

Type SCND6-A

Red Label

3-Pole, 600V AC	
Catalog Number	Max Current Rating
SCND69800AH■	800
SCND69100AH■	1000
SCND69120AH■	1200
SCND69800AGH■	800
SCND69100AGH■	1000
SCND69120AGH■	1200
SCND69800ANTH■	800
SCND69100ANTH■	1000
SCND69120ANTH■	1200
SCND69800ANGTH■	800
SCND69100ANGTH■	1000
SCND69120ANGTH■	1200

Trip Unit Adjustable Functions

Suffix Letter Code	Trip Type	Cont Current Setting	Long Time Delay	Instantaneous Setting	Short Time Pick Up	Short Time Delay	Short Time I ² t Pick Up	Ground Fault Pick Up	Ground Fault Delay
A	LI	✓	✓	✓					
AG	LIG	✓	✓	✓				✓	✓
ANT	LSI	✓	✓	✓	✓	✓	✓		
ANGT	LSIG	✓	✓	✓	✓	✓	✓	✓	✓

Interrupting Ratings

Breaker Type	RMS Symmetrical kA UL 489 (File E10848)		
	240V AC	480V AC	600V AC
SND6	65	50	25
SHND6	100	65	50
SCND6	200	100	65

Neutral Transformers

Ampere Rating	Catalog Number
800	N08SMDA
1000	N10SNDA
1200	N12SNDA

For inches / millimeters conversion, see Application Data section.

For ordering information and terminal connectors, and enclosures, see page 17/83.

Note: "G" suffix in catalog number denotes circuit breaker for 3-phase, 3-wire circuits.

For 3-phase, 4-wire, order correct 4th wire (neutral) transformer as separate and additional item.

■ Built to order. Allow 2-3 weeks for delivery.

① Use 2-3TA4P8500 for 3-pole. These kits are rated for 90°C wire. 90°C Cu only cable must be used, and sized per 75°C ampacity.

② SND6, SHND6 and SCND6 circuit breakers are UL Listed for reverse connection applications.

Molded Case Circuit Breaker

Internal Accessories

Selection

Accessories for:
MD/SMD 800A Frame
ND/SND 1200A Frame
PD/SPD 1600A Frame
RD 2000A Frame



Accessory modules can mount in either left hand or right hand poles of all circuit breakers, including solid state. Exception: when mechanical interlock is used. Accessories cannot be mounted in left pole.

Shunt Trip Combinations

Control Voltage		1 Shunt Trip	1 Shunt Trip and 1 Auxiliary Switch
AC	DC	Catalog Number	Catalog Number
120		S01MN6	S01MN64A
208		S02MN6▲	—
240		S03MN6	S03MN64A▲
277		S15MN6▲	S15MN64A▲
480		S04MN6▲	S04MN64A▲
600		S06MN6▲	—
	12	S16MN6▲	S16MN64A▲
	24	S07MN6	S07MN64A
	48	S09MN6▲	—
	125	S11MN6	S11MN64A▲
	250	S13MN6▲	S13MN64A▲

Undervoltage Trip Combinations

Control Voltage		1 Undervoltage Trip	1 Undervoltage Trip and 1 Auxiliary Switch	1 Undervoltage Trip and 2 Auxiliary Switches
AC	DC	Catalog Number	Catalog Number	Catalog Number
120		U01MN6	U01MN64A	U01MN64AA
208		U02MN6▲	U02MN64A▲	U02MN64AA▲
240		U03MN6▲	U03MN64A▲	U03MN64AA▲
277		U15MN6▲	U15MN64A▲	U15MN64AA▲
480		U04MN6▲	U04MN64A▲	U04MN64AA▲
600		U06MN6▲	—	—
	24	U07MN6	U07MN64A	U07MN64AA
	48	U09MN6▲	U09MN64A▲	U09MN64AA▲
	125	U11MN6▲	U11MN64A▲	U11MN64AA▲
	250	U13MN6▲	U13MN64A▲	U13MN64AA▲

Auxiliary Switch Combinations

Maximum Voltage		1 Form C	2 Form C
AC	DC	Catalog Number	Catalog Number
480	250	A01MN64	A02MN64
—	12	A01MNDLV▲	A02MNDLV▲

Alarm Switch Combinations

Maximum Voltage		1 Alarm Switch	1 Alarm Switch and 1 Auxiliary Switch	1 Alarm Switch and 2 Auxiliary Switches
AC	DC	Catalog Number	Catalog Number	Catalog Number
480	250	B00MN64	A01MN64B	A02MN64B

Plug-in Ammeter Display Units

Breaker Type	Description	Catalog Number
SMD, SND, SPD	Display Unit	SADU
	Remote Mounting Kit	SADURMK18

▲ Built to order. Allow 6–8 weeks for delivery.

Sentron Molded Case Circuit Breakers

PD 1600A Frame Sentron Series

Selection

Type PXD6^② Non-Interchangeable Trip^⑤

3-Pole 600V AC, 250-500V DC^①

Blue Label

Continuous Current Rating @ 40°C	Complete Breaker Assembled (Frame/Trip Unit Only) Catalog Number	Mounting Assembly Catalog Number	Lugs (6 required) Catalog Number
1200	PXD63B120■	MB9301	TA5P600
1400	PXD63B140■	-or-	
1600	PXD63B160	MBR9302	

Type PD6 Interchangeable Trip^⑤

3-Pole 600V AC, 250-500V DC^①

Blue Label

Continuous Current Rating @ 40°C	Complete Breaker Unassembled	Frame Only	Trip Unit Only	Mounting Assembly	Lugs (6 required)
	Catalog Number	Catalog Number	Catalog Number	Catalog Number	Catalog Number
1200	PD63B120■	PD63F160	PD63T120■	MB9301	TA5P600
1400	PD63B140		PD63T140	-or-	
1600	PD63B160		PD63T160	MBR9302	

Type HPXD6^② Non-Interchangeable Trip^⑤

3-Pole 600V AC, 250-500V DC^①

Blue Label

Continuous Current Rating @ 40°C	Complete Breaker Assembled (Frame/Trip Unit Only)	
	Catalog Number	
1200	HPXD63B120■	
1400	HPXD63B140■	
1600	HPXD63B160	

Type HPD6 Interchangeable Trip^⑤

3-Pole 600V AC, 250-500V DC^①

Black Label

Continuous Current Rating @ 40°C	Complete Breaker Unassembled	Frame Only	Trip Unit Only	Mounting Assembly	Lugs (6 required)
	Catalog Number	Catalog Number	Catalog Number	Catalog Number	Catalog Number
1200	HPD63B120■	HPD63F160	PD63T120■	MB9301	TA5P600
1400	HPD63B140		PD63T140	-or-	
1600	HPD63B160		PD63T160	MBR9302	

Type CPD6 Non-Interchangeable Trip^⑤

Fuseless Current Limiting
3-Pole 600V AC, 250-500V DC^①

Red Label

Continuous Current Rating @ 40°C	Complete Breaker Assembled (Frame/Trip Unit Only)	
	Catalog Number	
1200	CPD63B120■	
1400	CPD63B140■	
1600	CPD63B160■	

Interrupting Ratings

Breaker Type	UL 489 A IR				
	RMS Symmetrical KA				
	Volts AC			Volts DC ^①	
	240	480	600	250	500
PD6, PXD6	65	50	25	30 (2P)	25 (3P)
HPD6, HPXD6	100	65	50	30 (2P)	50 (3P)
CPD6	200	100	65	30 (2P)	50 (3P)

■ Built to order. Allow 2-3 weeks for delivery.

▲ Built to order. Allow 6-8 weeks for delivery.

① Use two outside poles of a 3-pole circuit breaker for 250V

② When wired as shown on page 17/5, this circuit breaker is

UL listed and rated for use on 500V DC ungrounded UPS systems only.

③ PXD6, HPXD6 and CPD6 type circuit breakers are UL Listed for reverse feed applications.

④ For additional information See **Note: A**, page 17/101.

Ordering Instructions

Complete Breaker Unassembled with Lugs

Prices of PD6, HPD6, RD6, and HRD6 type breakers include frame, trip, mounting base (MB9301), and both line and load lugs (PD Frame – TA5P600, RD Frame – TC5R600). When ordered by these catalog numbers, the customer will receive the frame, trip, mounting assembly and lugs separately packaged. For applications requiring different mounting base or lugs, order individual items as needed.

Complete Breaker Assembled without Lugs

Prices of PXD6, HPXD6, RXD6, HRXD6 and CPD6 type breakers include frame with non-interchangeable trip unit installed only. Order required mounting base and lugs separately.

100% Rated (3-Pole only)

Types PXD6, HPXD6 breakers are available with 100% ratings. To order add suffix "H" to catalog number, and 10% to list price. 100% PD breakers require 90° C cable sized at 75° C ampacity and TC5R600 lugs. RD 2000A Frames not available with 100% ratings.

50°C Applications see page 17/104.

400HZ Applications see page 17/104.

Lugs (6 required per breaker)^④

Catalog Number	No of Cables per Connector	Wire Range
TA5P600	1-5	300-600 kcmil Cu/Al
TC5R600	1-5	300-600 kcmil Cu only
TA4P750▲	1-4	500-750 kcmil Cu/Al
TA6R600	1-6	300-600 kcmil Cu/Al

④ HACR rated.

Note: PD frame qualified to UL489 supplement B "NAVAL". See page 17/104 for additional information.

Sentron Molded Case Circuit Breakers

SPD 1600A Frame Digital Solid State Sentron Sensitrip III Series

Selection/Dimensions

Ordering Information

Pricing information for all Digital Sentron Series PD frame unit is for breaker only. Price required mounting block assembly and necessary terminal connectors as separate items.

SPD6 and SHPD6 are acceptable for reverse connection applications.



Type SPD6

Blue Label

3-Pole, 600V AC	
Catalog Number	Max Current Rating
SPD69140■	1400
SPD69160■	1600
SPD69140G■	1400
SPD69160G■	1600
SPD69140NT■	1400
SPD69160NT■	1600
SPD69140NGT■	1400
SPD69160NGT■	1600

Type SHPD6

Black Label

3-Pole, 600V AC	
Catalog Number	Max Current Rating
SHPD69140■	1400
SHPD69160■	1600
SHPD69140G■	1400
SHPD69160G■	1600
SHPD69140NT■	1400
SHPD69160NT■	1600
SHPD69140NGT■	1400
SHPD69160NGT■	1600

Lugs^①

Catalog Number	No. of Cables per Connector	Wire Range
TA5P600	1-5 pcs.	300-600 kcmil Cu/Al
TC5R600	1-5 pcs.	300-600 kcmil Cu Only
TA6R600	1-6 pcs.	300-600 kcmil Cu/Al

Neutral Transformers

Ampere Rating	Catalog Number
1400	N14SPD
1600	N16SPD

Enclosure

Type	Catalog Number
1	PRD6N1

Suffix Letter Code	Trip Type	Cont Current Setting	Long Time Delay	Instantaneous Setting	Short Time Pick Up	Short Time Delay	Short Time I ² t Pick Up	Ground Fault Pick Up	Ground Fault Delay
None	LI	✓	✓	✓					
G	LIG	✓	✓	✓				✓	✓
NT	LSI	✓	✓	✓	✓	✓	✓		
NGT	LSIG	✓	✓	✓	✓	✓	✓	✓	✓

Interrupting Ratings

Breaker Type	RMS Symmetrical kA UL 489		
	240V AC	480V AC	600V AC
SPD6	65	50	25
SHPD6	100	65	50

Mounting Block (Required)^②

Catalog Number
MB9301
MBR9302

All PD, RD Frames:

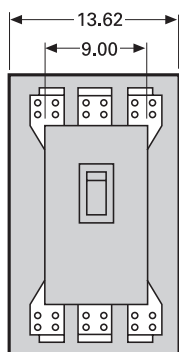

MB9301 (shown)
MBR9302

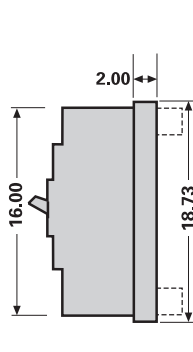

MBR9302

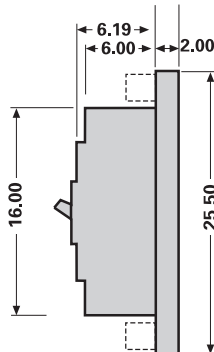

MB9301

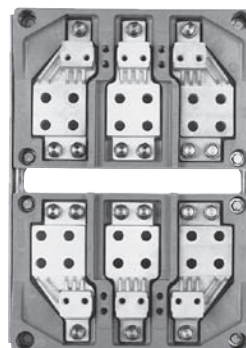

MBR9302



MB9301

For inches / millimeters conversion, see Application Data section.

■ Built to order. Allow 2-3 weeks for delivery.

①For additional information, see Note A, page 17/101.

②The PD frame circuit breaker requires the use of a connect-all mounting assembly to allow for placing into service.

Note: "G" suffix in catalog number denotes circuit breaker for 3-phase, 3-wire circuits.

For 3-phase, 4-wire, order correct 4th wire (neutral) transformer as separate and additional item.

Sentron Molded Case Circuit Breakers

RD 2000A Frame Sentron Series

Selection

Type RXD6^④

3-Pole 600V AC, 250-500V DC^①

Blue Label

Non-Interchangeable Trip (Assembled Circuit Breaker Only Without Lugs)			
Continuous Current Rating @ 40°C	Complete Breaker Assembled (Frame/ Trip Unit Only) Catalog Number	Mounting Assembly Catalog Number	Lugs (6 required) Catalog Number
1600	RXD63B160	MB9301	TC5R600
1800	RXD63B180	-or-	
2000	RXD63B200	MBR9302	

Type RD6^④

3-Pole 600V AC, 250-500V DC^①

Blue Label

Interchangeable Trip (Unassembled Circuit Breaker with Lugs)					
Continuous Current Rating @ 40°C	Complete Breaker Unassembled Catalog Number	Frame Only Catalog Number	Trip Unit Only Catalog Number	Mounting Assembly Catalog Number	Lugs (6 required) Catalog Number
1600	RD63B160■	RD63F200	RD63T160■	MB9301	TC5R600
1800	RD63B180		RD63T180	-or-	
2000	RD63B200		RD63T200	MBR9302	



Mounting Block^⑥

Catalog Number	Connection Points
MB9301 MBR9302	Front Rear

Type HRXD6^④

Black Label

Continuous Current Rating @ 40°C	Complete Breaker Assembled (Frame/ Trip Unit Only)	
	Catalog Number	
1600	HRXD63B160■	
1800	HRXD63B180■	
2000	HRXD63B200	

Shipping Weights

Number of Poles	Number per Carton	Shipping Weight (lbs.)
PXD6, HPXD6, RXD6, HRXD6, CPD6 Assembled Breakers		
3	1	61.5
PD6, HPD6, RD6, HRD6 Frame Only		
3	1	55.0
PD6, RD6 Trip Unit Only		
3	1	6.5
Mounting Assembly		
MB9301	1	53.0
MBR9302	1	50.9

Type HRD6^④

Black Label

Continuous Current Rating @ 40°C	Complete Breaker Unassembled Catalog Number	Frame Only Catalog Number	Trip Unit Only Catalog Number	Mounting Assembly Catalog Number	Lugs (6 required) Catalog Number
1600	HRD63B160■	HRD63F200	RD63T160■	MB9301	TC5R600
1800	HRD63B180		RD63T180	-or-	
2000	HRD63B200		RD63T200	MBR9302	

Interrupting Ratings

Breaker Type	UL 489 A IR				
	RMS Symmetrical KA				
	Volts AC			Volts DC ^①	
	240	480	600	250	500
RD6, RXD6	65	50	25	30 (2P)	25 (3P)
HRD6, HRXD6	100	65	50	30 (2P)	50 (3P)

Lugs (6 required per breaker)^⑤

Catalog Number	No of Cables per Connector	Wire Range
TC5R600	1-5	300-600 kcmil Cu only
TA6R600	1-6	300-600 kcmil Cu/Al

Instantaneous Adjustment Trip Range (PD / RD Frames)

Breaker Ampere Rating	Nominal Instantaneous Values							±20% Tolerance High
	±20% Tolerance Low	2	3	4	5	6	7	
	1200-2000	5000	5715	6430	7145	7860	8575	

■ Built to order. Allow 2-3 weeks for delivery.

▲ Built to order. Allow 6-8 weeks for delivery.

① Use two outside poles of a 3-pole circuit breaker for 250V DC applications.

② When wired as shown on page 17/5, this circuit breaker is UL listed and rated for use on 500V DC ungrounded UPS systems only.

③ RXD6 and HRXD6 type circuit breakers are UL Listed for reverse feed applications.

④ HACR rated.

⑤ For additional information See **Note: A**, page 17/101
Note: RD frame qualified to UL489 supplement B "NAVAL".
See page 17/104 for additional information.

⑥ For required mounting base (MB9301 or MBR9302) see page 17/88.

Sentron Molded Case Circuit Breakers

Internal Accessories

Selection/Dimensions

Accessories for:

MD/SMD 800A Frame
ND/SND 1200A Frame
PD/SPD 1600A Frame
RD 2000A Frame



Accessory modules can mount in either left hand or right hand poles of all circuit breakers, including solid state. Exception: when mechanical interlock is used. Accessories cannot be mounted in left pole.

Sensitrip Ammeter



The Ammeter Display Units plug into the Sensitrip Trip Unit and displays the phase current flowing in the breaker. They are powered by the breaker's CT's with replaceable battery back-up for maintaining trip and max logs.

The SADU reads currents, current imbalance, current demand, and trip status.

Ammeter Mounting Kit

The Ammeter may also be panel or door mounted using the SADURMK18 remote mounting kit.

Shunt Trip Combinations

Control Voltage		1 Shunt Trip	1 Shunt Trip and 1 Auxiliary Switch
AC	DC	Catalog Number	Catalog Number
120		S01MN6	S01MN64A
208		S02MN6▲	—
240		S03MN6	S03MN64A▲
277		S15MN6▲	S15MN64A▲
480		S04MN6▲	S04MN64A▲
600		S06MN6▲	—
	12	S16MN6▲	S16MN64A▲
	24	S07MN6	S07MN64A
	48	S09MN6▲	—
	125	S11MN6	S11MN64A▲
	250	S13MN6▲	S13MN64A▲

Undervoltage Trip Combinations

Control Voltage		1 Undervoltage Trip	1 Undervoltage Trip and 1 Auxiliary Switch	1 Undervoltage Trip and 2 Auxiliary Switches
AC	DC	Catalog Number	Catalog Number	Catalog Number
120		U01MN6	U01MN64A	U01MN64AA
208		U02MN6▲	U02MN64A▲	U02MN64AA▲
240		U03MN6▲	U03MN64A▲	U03MN64AA▲
277		U15MN6▲	U15MN64A▲	U15MN64AA▲
480		U04MN6▲	U04MN64A▲	U04MN64AA▲
600		U06MN6▲	—	—
	24	U07MN6	U07MN64A	U07MN64AA
	48	U09MN6▲	U09MN64A▲	U09MN64AA▲
	125	U11MN6▲	U11MN64A▲	U11MN64AA▲
	250	U13MN6▲	U13MN64A▲	U13MN64AA▲

Auxiliary Switch Combinations

Maximum Voltage		1 Form C	2 Form C
AC	DC	Catalog Number	Catalog Number
480	250	A01MN64	A02MN64
—	12	A01MNDLV▲	A02MNDLV▲

Alarm Switch Combinations

Maximum Voltage		1 Alarm Switch	1 Alarm Switch and 1 Auxiliary Switch	1 Alarm Switch and 2 Auxiliary Switches
AC	DC	Catalog Number	Catalog Number	Catalog Number
480	250	B00MN64	A01MN64B	A02MN64B

Plug-in Ammeter Display Units

Breaker Type	Description	Catalog Number
SMD, SND, SPD	Display Unit	SADU
	Remote Mounting Kit	SADURMK18

▲ Built to order. Allow 6–8 weeks for delivery.

Sentron Molded Case Circuit Breakers

Magnetic Trip Only — ETI Motor Circuit Protector

Selection

Breaker Type	Ampere Rating	Instantaneous Trip Range ^②		Complete Circuit Breaker Without Lugs ^⑤	
		Minimum ^③	Maximum ^③	Catalog Number 2-Pole	Catalog Number 3-Pole
HEM	3	9	33	—	HEM3M003L
	7	21	77	—	HEM3M007L
	15	45	165	—	HEM3M015L
	30	90	330	—	HEM3M030L
	50	150	550	—	HEM3M050L
	70	210	770	—	HEM3M070L
	100	300	1100	—	HEM3M100L
SHIPPING:					3.7 lbs. each
ED6-A 600V AC 250V DC	1	2.6	9	—	ED63A001
	2	7	22	—	ED63A002
	3	10	35	—	ED63A003
	5	16	54	—	ED63A005
	10	30	100	—	ED63A010
	25	55	180	—	ED63A025
	30	80	270	—	ED63A030
	40	115	375	—	ED63A040
	50	180	600	—	ED63A050
	100	315	1000	—	ED63A100
	125	500	1250	—	ED63A125
	SHIPPING:				
CED6-A 600V AC 250V DC	1	2.6	9	—	CED63A001■
	2	7	22	—	CED63A002■
	3	10	35	—	CED63A003■
	5	16	54	—	CED63A005■
	10	30	100	—	CED63A010■
	25	55	180	—	CED63A025■
	30	80	270	—	CED63A030■
	40	115	375	—	CED63A040■
	50	180	600	—	CED63A050■
	100	315	1000	—	CED63A100■
	125	500	1250	—	CED63A125■
	SHIPPING:				
FXD6 ^④ 600V AC 250V DC	150	400	800	—	FXD63L150■
	150	800	1500	—	FXD63A150
	150	1100	2500	—	FXD63H150
	250	1100	2500	—	FXD63A250
SHIPPING:					9 lbs. each
CFD6 ^④ 600V AC 250V DC	150	400	800	—	CFD63L150■
	150	800	1500	—	CFD63A150■
	150	1100	2500	—	CFD63H150■
	250	1100	2500	—	CFD63A250■
SHIPPING:					12 lbs. each
JXD6(A) ^① 600V AC 250V DC	400	1250	2500	—	JXD63L400
	400	2000	4000	JXD62H400■	JXD63H400
SHIPPING:					16 lbs. each
CJD6 ^① 600V AC 250V DC	400	1250	2500	—	CJD63L400■
	400	2000	4000	—	CJD63H400■
SHIPPING:					29.5 lbs. each
LXD6(A) ^① 600V AC 250V DC	600	2000	4000	LXD62L600■	LXD63L600■
	600	3000	6000	—	LXD63H600
SHIPPING:					16 lbs. each
CLD6 ^① 600V AC 250V DC	600	2000	4000	—	CLD63L600■
	600	3000	6000	—	CLD63H600■
SHIPPING:					31.5 lbs. each
LMXD6 ^④ 600V AC 250V DC	800	2800	6000	—	LMXD63L800■
	800	3200	8000	—	LMXD63A800
SHIPPING:					35 lbs. each
MXD6 ^④ 600V AC 250V DC	800	3000	6000	—	MXD63L800■
	800	4000	8000	—	MXD63A800■
	800	5000	10000	—	MXD63H800
SHIPPING:					33 lbs. each
CMD6 ^④ 600V AC 250V DC	800	3000	6000	—	CMD63L800■
	800	4000	8000	—	CMD63A800■
	800	5000	10000	—	CMD63H800■
SHIPPING:					80 lbs. each

Important Information

ETI interrupting ratings are determined through combination tests with properly sized overload relays and contactors.

⑤ **Connectors included when ordering by circuit breaker catalog number for HEM, ED and CED6 ETIs. Order ETI circuit breaker and lugs (2 per pole) separately for the FXD6, CFD6, MXD6, CMD6, JXD6, CJD6, LXD6 and CLD6 ETI's.**

■ Built to order. Allow 2-3 weeks for delivery.

① 2-pole available in 3-pole width only.

② When applied on DC Circuits — Trip levels will increase approximately +15 to 20%.

③ Tolerance -20%/+30% for lowest setting. All other set-

tings are -20%/+20%

④ For 2-pole application use outside poles of 3-pole circuit breaker.

Lug Information pages 17/101 to 17/103
Accessories pages 17/108 to 17/113
Application data pages 17/92 to 17/93

1
2
3
4
5
6
7
8
9
10
11
12
13
14
15
16
17

Sentron Molded Case Circuit Breakers

Motor Circuits

Application

General

Protection of Motor Circuits

Molded case circuit breakers are used in motor circuits as a disconnecting means and for short-circuit protection. They should be used in conjunction with motor-running, over-current-protection devices, and should permit the motor to start without nuisance tripping from motor-inrush current. The circuit breaker should have a continuous-current rating of not less than 115% of the motor full-load current.

The recommended motor circuit protectors (Siemens ETI instantaneous only circuit breakers) listed have

continuous-current ratings of at least 115% of motor full-load currents. The trip-setting positions are approximately 11 times motor full-load currents. The suggested trip settings may have to be adjusted upward to no higher than 1300% of full-load current for non-design E type motors, and no greater than 1700% of full load current for design E motors, to allow for motor start-up due to inrush currents.

Breaker Mounted Immediately Ahead of Motor Starter

Siemens ETI motor circuit protectors are recommended for use in combination motor starters to provide selective short-circuit protection for the motor

branch circuit. The adjustable instantaneous-trip feature of the Siemens ETI motor circuit protector provides for a trip setting slightly above the peak motor-inrush current. With this setting, no delay is introduced in opening the circuit when a fault occurs. This circuit breaker has no time-delay trip element. Therefore it must be used in conjunction with, and immediately ahead of, the motor-running overcurrent protective device.

Important: The information below does not apply to all motor applications: it is recommended that the user refer to the National Electrical Code (NEC) for specific needs.

Table 1 (When Breaker is Mounted Immediately Ahead of Motor Starter)

3-Phase Induction Type Motors (Siemens ETI motor circuit protectors for branch circuit use with alternating-current combination, full voltage motor starters).

Motor Full Load Amperes	Catalog Number	ETI Trip Setting	
		Adjustment	Amperes
0.69 – 0.91	HEM3M003L	A (min)	9
1.1 – 1.3		B	15
1.6 – 1.7		C	21
2.0 – 2.2		D	27
2.3 – 2.5		E	30
2.6 – 2.8		F (max)	33
1.5 – 2.0	HEM3M007L	A (min)	21
2.6 – 3.1		B	35
3.7 – 3.9		C	49
4.8 – 5.2		D	63
5.3 – 5.7		E	70
5.8 – 6.1		F (max)	77
3.4 – 4.5	HEM3M015L	A (min)	45
5.7 – 6.8		B	75
8.0 – 9.1		C	100
10.4 – 11.4		D	135
11.5 – 12.6		E	150
12.7 – 13.0		F (max)	165
3.9 – 9.1	HEM3M030L	A (min)	90
11.5 – 13.7		B	150
16.1 – 18.3		C	210
20.7 – 22.9		D	270
23.0 – 25.2		E	300
25.3 – 26.1		F (max)	330
11.5 – 15.2	HEM3M050L	A (min)	150
19.2 – 22.9		B	250
26.9 – 30.6		C	350
34.6 – 38.3		D	450
38.4 – 42.1		E	500
42.2 – 43.5		F (max)	550
16.1 – 30.6	HEM3M070L	A (min)	210
26.9 – 32.2		B	350
37.6 – 42.9		C	490
48.4 – 53.7		D	630
53.8 – 59.1		E	700
59.2 – 60.9		F (max)	770
23.0 – 30.9	HEM3M100L	A (min)	300
38.4 – 46.0		B	500
53.8 – 61.4		C	700
69.2 – 76.8		D	900
76.9 – 84.5		E	1000
84.6 – 87.0		F (max)	1100
.20 – .33	ED63A001 CED63A001	Low	2.6
.34 – .45		2	4.5
.46 – .56		3	6
.57 – .68		4	7.5
.69 – .81		High	9
.53 – .83	ED63A002 CED63A002	Low	7
.84 – 1.14		2	11
1.15 – 1.45		3	15
1.46 – 1.68		4	19
1.69 – 2.00		High	22
.76 – 1.29	ED63A003 CED63A003	Low	10
1.30 – 1.75		2	17
1.76 – 2.29		3	23
2.30 – 2.68		4	30
2.69 – 3.18		High	35

Motor Full Load Amperes	Catalog Number	ETI Trip Setting	
		Adjustment	Amperes
1.23 – 1.99	ED63A005 CED63A005	Low	16
2.00 – 2.75		2	26
2.76 – 3.52		3	36
3.53 – 4.14		4	46
4.15 – 4.90		High	54
2.30 – 3.83	ED63A010 CED63A010	Low	30
3.84 – 5.37		2	50
5.38 – 6.52		3	70
6.53 – 7.68		4	85
7.69 – 9.10		High	100
4.23 – 6.91	ED63A025 CED63A025	Low	55
6.92 – 9.61		2	90
9.62 – 11.91		3	125
11.92 – 13.83		4	155
13.84 – 16.40		High	180
6.15 – 10.37	ED63A030 CED63A030	Low	80
10.38 – 14.22		2	135
14.23 – 18.06		3	185
18.07 – 20.75		4	235
20.76 – 24.50		High	270
8.84 – 14.22	ED63A040 CED63A040	Low	115
14.23 – 19.60		2	185
19.61 – 24.99		3	255
25.00 – 28.83		4	325
28.84 – 34.00		High	375
13.84 – 23.06	ED63A050 CED63A050	Low	180
23.07 – 31.52		2	300
31.53 – 39.99		3	410
40.00 – 46.14		4	520
46.15 – 54.50		High	600
24.23 – 41.52	ED63A100 CED63A100	Low	315
41.53 – 56.91		2	540
56.92 – 68.45		3	740
68.46 – 76.91		4	890
76.92 – 90.90		High	1000
38.46 – 55.37	ED63A125 CED63A125	Low	500
55.38 – 70.75		2	720
70.76 – 84.60		3	920
84.61 – 96.14		4	1100
96.15 – 113.60		High	1250
30.76 – 35.37	FXD63L150 CFD63L150	Low	400
35.38 – 39.99		2	460
44.51 – 49.23		4	580
53.84 – 58.45		6	700
58.46 – 63.06		7	760
63.07 – 74.50		High	820
61.53 – 69.22		FXD63A150 CFD63A150	Low
69.23 – 76.91	2		900
84.61 – 92.29	4		1100
100.00 – 108.00	6		1300
108.00 – 115.00	7		1400
115.00 – 136.00	High		1500
85.00 – 100.00	FXD63A250 CFD63A250	Low	1100
100.00 – 115.00		2	1300
131.00 – 146.00		4	1700
162.00 – 177.00		6	2100
177.00 – 192.00		7	2300
192.00 – 227.00		High	2500

Motor Full Load Amperes	Catalog Number	ETI Trip Setting	
		Adjustment	Amperes
95.00 – 110.00	JXD63L400 CJD63L400	Low	1250
110.00 – 124.00		2	1430
138.00 – 151.00		4	1790
165.00 – 178.00		6	2140
178.00 – 192.00		7	2320
192.00 – 227.00		High	2500
154.00 – 176.00		JXD63H400 CJD63H400	Low
176.00 – 198.00	2		2290
220.00 – 242.00	4		2860
264.00 – 285.00	6		3430
285.00 – 308.00	7		3710
308.00 – 326.00	High		4000
155.00 – 176.00	LXD63L600 CLD63L600	Low	2000
176.00 – 198.00		2	2290
220.00 – 242.00		4	2860
264.00 – 285.00		6	3430
285.00 – 308.00		7	3710
308.00 – 326.00		High	4000
231.00 – 264.00		LXD63H600 CLD63H600	Low
264.00 – 292.00	2		3430
330.00 – 362.00	4		4290
395.00 – 428.00	6		5140
428.99 – 462.00	7		5570
462.00 – 490.00	High		6000
215.00 – 238.00	LXMD63L800	Low	2800
238.00 – 261.00		2	3100
261.00 – 284.00		3	3400
308.00 – 369.00		5	4000
369.00 – 423.00		6	4800
423.00 – 462.00		7	5500
462.00 – 490.00		High	6000
246.00 – 269.00	LXMD63A800	Low	3200
269.00 – 284.00		2	3500
284.00 – 323.00		3	3700
362.00 – 492.00		5	4700
492.00 – 562.00		6	6400
562.00 – 616.00		7	7300
616.00 – 660.00	High	8000	
231.00 – 264.00	MXD63L800 CMD63L800	Low	3000
264.00 – 292.00		2	3430
292.00 – 330.00		3	3800
362.00 – 395.00		5	4710
428.00 – 462.00		7	5570
462.00 – 490.00		High	6000
308.00 – 352.00	MXD63A800 CMD63A800	Low	4000
352.00 – 442.00		2	4570
442.00 – 447.00		3	5740
483.00 – 527.00		5	6280
571.00 – 616.00		7	7240
616.00 – 660.00		High	8000
385.00 – 440.00	MXD63H800 CMD63H800	Low	5000
495.00 – 550.00		3	6430
605.00 – 660.00		5	7860
660.00 – 695.00		6	8575

Note: Lowest instantaneous settings have a -20%/+30% tolerance and all other settings have a -20%/+20% tolerance.

Sentron Molded Case Circuit Breakers

Motor Circuits

Application

Breaker Mounted at a Distance From Motor Starter

ET thermal-magnetic circuit breakers conform to the National Electrical Code table 430-152 requirements for motor branch and feeder circuit protection when properly applied in conjunction with motor-running overcurrent protective devices. The recommended

circuit-breaker ratings in Table 2 provide adequate time delay for starting the majority of three phase induction motors.

To determine the ampere ratings of the ET breaker to protect a motor feeder, add the rating of the ET breaker used to protect the largest motor branch circuit in the group to the full-load currents of the remaining motors in the group.

Interrupt Ratings

For normal commercial purposes, available fault current can conveniently be obtained in the Interrupting Selector Tables.

Table 2 (When Breaker is Mounted at a Distance From Motor Starter)

3-Phase Induction Type Motors (EQ and ET circuit breakers (thermal-magnetic trip) for branch breaker use with alternating-current combination motor starters).

Motor Horsepower Rating	200 and 208V Motors			230V Motors			460V Motors			575V Motors		
	240V Circuit Breaker Data ^①			240V Circuit Breaker Data ^①			480V Circuit Breaker Data ^①			600V Circuit Breaker Data ^①		
	Breaker Type	Catalog Number	Ampere Rating	Breaker Type	Catalog Number	Ampere Rating	Breaker Type	Catalog Number	Ampere Rating	Breaker Type	Catalog Number	Ampere Rating
½	BQ [®]	BQ3B015	15	BQ [®]	BQ3B015	15	ED4	ED43B015	15	ED6	ED63B015	15
¾		BQ3B015	15		BQ3B015	15		ED43B015	15		ED63B015	15
1		BQ3B015	15		BQ3B015	15		ED43B015	15		ED63B015	15
1½		BQ3B015	15		BQ3B015	15		ED43B015	15		ED63B015	15
2		BQ3B020	20		BQ3B015	15		ED43B015	15		ED63B015	15
3		BQ3B030	30		BQ3B020	20		ED43B015	15		ED63B015	15
5	BQ [®]	BQ3B040	40	BQ [®]	BQ3B030	30	ED4	ED43B015	15	ED6	ED63B015	15
7½		BQ3B060	60		BQ3B050	50		ED43B030	30		ED63B020	20
10		BQ3B070	70		BQ3B070	70		ED43B030	30		ED63B030	30
15		BQ3B100	100		BQ3B090	90		ED43B040	40		ED63B035	35
20					BQ3B100	100		ED43B050	50		ED63B050	50
25	FXD6	FXD63B125	125	FXD6	FXD63B125	125	FXD6	FXD63B090	90	FXD6	FXD63B060	60
30		FXD63B150	150		FXD63B150	150		FXD63B100	100		FXD63B070	70
40		FXD63B175	175		FXD63B175	175		FXD63B125	125		FXD63B090	90
50		FXD63B200	200		FXD63B200	200		FXD63B150	150		FXD63B100	100
50		FXD63B225	225									
60	JXD2	JXD23B300	300	—	—	—	FXD6, FD6	FXD63B150	150	FXD6	FXD63B100	100
75	JXD2	JXD23B400	400	JXD2	JXD23B350	350	FXD6, FD6	FXD63B200	200	FXD6, FD6	FXD63B125	125
100	JXD2	JXD23B400	400	JXD2	JXD23B400	400	FD6 [®] JD6 [®]	FD63B250 JD63B250	250 250	FXD6, FD6	FD63B175	175
125	LD6 [®] or LMD6	LD63B600 LMD63B600	600	LD6 [®] or LMD6	LD63B500 or LMD63B500	500	JD6 [®]	JD63B300	300	FXD6, FD6 OR JD6 [®]	FXD63B200 JD63B200	200 200
150	LD6 [®] or LMD6	LD63B600 or LMD63B600	600	LMD6	LD63B600 or LMD63B600	600	JD6 [®]	JD63B300	300	FXD6 or JD6 [®]	FXD63B225 JD63B225	225 225
200	LMD6	LMD63B800	800	LMD6	LMD63B800	800	JD6 [®]	JD63B350	350	JD6 [®]	JD63B300	300
250	—	—	—	—	—	—	JD6 [®]	JD63B400	400	JD6 [®]	JD63B400	400
300	—	—	—	—	—	—	LD6 [®] or LMD6	LD63B600 or LMD63B600	600	JD6 [®]	JD63B400	400
350	—	—	—	—	—	—	LMD6	LMD63B700	700	LD6 [®] or LMD6	LD63B500 or LMD63B500	500
400	—	—	—	—	—	—	LMD6	LMD63B800	800	LD6 [®] or LMD6	LD63B600 or LMD63B600	600
500	—	—	—	—	—	—	—	—	—	LMD6	LMD63B800	800

①The selection of breakers for this table is in accordance with Article 430, 2005 National Electric Code. Recommended circuit breakers are for full voltage starting, special consideration is necessary for reduced voltage starting.

②For panelboard applications, substitute the BL breaker for the BQ, ED2 circuit breakers may also be used.

③For non-interchangeable trip applications, substitute the FXD6 for the FD6, the JXD6 for the JD6, or the LXD6 for the LD6.

Sentron Molded Case Circuit Breakers

Adjustable Installments Magnetic Trip Settings

Application

Breaker Type	Maximum Continuous Amperes	Nominal AC Adjustable Trip Range								ETI Motor Circuit Protector Catalog Number	Thermal Magnetic Catalog Number	
		Low	2	3	4	5	6	7	High		3-Pole	2-Pole
HEM	3	9	15	21	27	30	—	—	33	HEM3M003L	—	—
	7	21	35	49	63	70	—	—	77	HEM3M007L	—	—
	15	45	75	100	135	150	—	—	165	HEM3M015L	—	—
	30	90	150	210	270	300	—	—	330	HEM3M030L	—	—
	50	150	250	350	450	500	—	—	550	HEM3M050L	—	—
	70	210	350	490	630	700	—	—	770	HEM3M070L	—	—
	100	300	500	700	900	1000	—	—	1100	HEM3M100L	—	—
ED6	1	2.6	4.5	6	7.5	—	—	—	9	ED63A001	—	—
	2	7	11	15	19	—	—	—	22	ED63A002	—	—
	3	10	17	23	30	—	—	—	35	ED63A003	—	—
	5	16	26	36	46	—	—	—	54	ED63A005	—	—
	10	30	50	70	85	—	—	—	100	ED63A010	—	—
	25	55	90	125	155	—	—	—	180	ED63A025	—	—
	30	80	135	185	235	—	—	—	270	ED63A030	—	—
	40	115	185	255	325	—	—	—	375	ED63A040	—	—
	50	180	300	410	520	—	—	—	600	ED63A050	—	—
	100	315	540	740	890	—	—	—	1000	ED63A100	—	—
	125	500	720	920	1100	—	—	—	1250	ED63A125	—	—
	CED6	1	2.6	4.5	6	7.5	—	—	—	9	CED63A001■	—
2		7	11	15	19	—	—	—	22	CED63A002■	—	—
3		10	17	23	30	—	—	—	35	CED63A003■	—	—
5		16	26	36	46	—	—	—	54	CED63A005■	—	—
10		30	50	70	85	—	—	—	100	CED63A010■	—	—
25		55	90	125	155	—	—	—	180	CED63A025■	—	—
30		80	135	185	235	—	—	—	270	CED63A030■	—	—
40		115	185	255	325	—	—	—	375	CED63A040■	—	—
50		180	300	410	520	—	—	—	600	CED63A050	—	—
100		315	540	740	890	—	—	—	1000	CED63A100	—	—
125		500	720	920	1100	—	—	—	1250	CED63A125	—	—
FXD6-A		70	600	640	690	730	770	810	850	900	—	FXD62B070
	80	600	640	690	730	770	810	850	900	—	FXD62B080	FXD63B080
	90	600	640	690	730	770	810	850	900	—	FXD62B090	FXD63B090
	100	700	770	840	920	990	1060	1140	1200	—	FXD62B100	FXD63B100
	110	700	770	840	920	990	1060	1140	1200	—	FXD62B110	FXD63B110
	125	800	900	1000	1100	1200	1300	1400	1500	—	FXD62B125	FXD63B125
	150	400	460	520	580	640	700	760	820	FXD63L150	—	—
	150	800	900	1000	1100	1200	1300	1400	1500	FXD63A150	FXD62B150	FXD63B150
	150	1100	1300	1500	1700	1900	2100	2300	2500	FXD63H150	—	—
	175	900	1060	1210	1370	1520	1780	1930	2000	—	FXD62B175	FXD63B175
	200	900	1060	1210	1370	1520	1780	1930	2000	—	FXD62B200	FXD63B200
	225	1100	1300	1500	1700	1900	2100	2300	2500	—	FXD62B225	FXD63B225
250	1100	1300	1500	1700	1900	2100	2300	2500	FXD63A250	FXD62B250	FXD63B250	
FD6-A	70	600	640	690	730	770	810	850	900	—	FD62B070	FD63B070
	80	600	640	690	730	770	810	850	900	—	FD62B080	FD63B080
	90	600	640	690	730	770	810	850	900	—	FD62B090	FD63B090
	100	700	770	840	920	990	1060	1140	1200	—	FD62B100	FD63B100
	110	700	770	840	920	990	1060	1140	1200	—	FD62B110	FD63B110
	125	800	900	1000	1100	1200	1300	1400	1500	—	FD62B125	FD63B125
	150	800	900	1000	1100	1200	1300	1400	1500	—	FD62B150	FD63B150
	175	900	1060	1210	1370	1520	1780	1930	2000	—	FD62B175	FD63B175
	200	900	1060	1210	1370	1520	1780	1930	2000	—	FD62B200	FD63B200
	225	1100	1300	1500	1700	1900	2100	2300	2500	—	FD62B225	FD63B225
	250	1100	1300	1500	1700	1900	2100	2300	2500	—	FD62B250	FD63B250
	HFD6	70	600	640	690	730	770	810	850	900	—	HFD62B070
80		600	640	690	730	770	810	850	900	—	HFD62B080	HFD63B080
90		600	640	690	730	770	810	850	900	—	HFD62B090	HFD63B090
100		700	770	840	920	990	1060	1140	1200	—	HFD62B100	HFD63B100
110		700	770	840	920	990	1060	1140	1200	—	HFD62B110	HFD63B110
125		800	900	1000	1100	1200	1300	1400	1500	—	HFD62B125	HFD63B125
150		800	900	1000	1100	1200	1300	1400	1500	—	HFD62B150	HFD63B150
175		900	1060	1210	1370	1520	1780	1930	2000	—	HFD62B175	HFD63B175
200		900	1060	1210	1370	1520	1780	1930	2000	—	HFD62B200	HFD63B200
225		1100	1300	1500	1700	1900	2100	2300	2500	—	HFD62B225	HFD63B225
250		1100	1300	1500	1700	1900	2100	2300	2500	—	HFD62B250	HFD63B250
HHFD6		70	600	640	690	730	770	810	850	900	—	HHFD63B070
	80	600	640	690	730	770	810	850	900	—	HHFD63B080	HHFD63B080
	90	600	640	690	730	770	810	850	900	—	HHFD63B090	HHFD63B090
	100	700	770	840	920	990	1060	1140	1200	—	HHFD63B100	HHFD63B100
	110	700	770	840	920	990	1060	1140	1200	—	HHFD63B110	HHFD63B110
	125	800	900	1000	1100	1200	1300	1400	1500	—	HHFD63B125	HHFD63B125
	150	800	900	1000	1100	1200	1300	1400	1500	—	HHFD63B150	HHFD63B150
	175	900	1060	1210	1370	1520	1780	1930	2000	—	HHFD63B175	HHFD63B175
	200	900	1060	1210	1370	1520	1780	1930	2000	—	HHFD63B200	HHFD63B200
	225	1100	1300	1500	1700	1900	2100	2300	2500	—	HHFD63B225	HHFD63B225
	250	1100	1300	1500	1700	1900	2100	2300	2500	—	HHFD63B250	HHFD63B250
	CFD6	70	600	640	690	730	770	810	850	900	—	CFD62B070
80		600	640	690	730	770	810	850	900	—	CFD62B080	CFD63B080
90		600	640	690	730	770	810	850	900	—	CFD62B090	CFD63B090
100		700	770	840	920	990	1060	1140	1200	—	CFD62B100	CFD63B100
110		700	770	840	920	990	1060	1140	1200	—	CFD62B110	CFD63B110
125		800	900	1000	1100	1200	1300	1400	1500	—	CFD62B125	CFD63B125
150		400	460	520	580	640	700	760	820	CFD63L150	—	—
150		800	900	1000	1100	1200	1300	1400	1500	CFD63A150	CFD62B150	CFD63B150
150		1100	1300	1500	1700	1900	2100	2300	2500	CFD63H150	—	—
175		900	1060	1210	1370	1520	1780	1930	2000	—	CFD62B175	CFD63B175
200		900	1060	1210	1370	1520	1780	1930	2000	—	CFD62B200	CFD63B200
225		1100	1300	1500	1700	1900	2100	2300	2500	—	CFD62B225	CFD63B225
250	1100	1300	1500	1700	1900	2100	2300	2500	CFD63A250	CFD62B250	CFD63B250	

Note: Tolerances for instantaneous trip points meet UL 489 (7.3). Nominal AC instantaneous trip points are given in the tables. For DC instantaneous trip points, add 15% to nominal values.

Instantaneous trip adjustment is made through the breaker cover on all frame breakers. To change instantaneous trip point on circuit breaker, depress indicating knob, then rotate to desired position.

■ Built to order. Allow 2–3 weeks for delivery.

Sentron Molded Case Circuit Breakers

Adjustable Instantaneous Magnetic Trip Settings

Application

Breaker Type	Maximum Continuous Amperes	Nominal AC Adjustable Trip Range								ETI Motor Circuit Protector Catalog Number	Thermal Magnetic Catalog Number	
		Low	2	3	4	5	6	7	High	3-Pole	2-Pole	3-Pole
JXD2(A)	200	1250	1430	1610	1790	1960	2140	2320	2500	—	JXD22B200	JXD23B200
	225	1250	1430	1610	1790	1960	2140	2320	2500	—	JXD22B225	JXD23B225
	250	1250	1430	1610	1790	1960	2140	2320	2500	—	JXD22B250	JXD23B250
	300	1250	1430	1610	1790	1960	2140	2320	2500	—	JXD22B300	JXD23B300
	350	2000	2290	2570	2860	3140	3430	3710	4000	—	JXD22B350	JXD23B350
	400	2000	2290	2570	2860	3140	3430	3710	4000	—	JXD22B400	JXD23B400
JXD6(A)	200	1250	1430	1610	1790	1960	2140	2320	2500	—	JXD62B200	JXD63B200
	225	1250	1430	1610	1790	1960	2140	2320	2500	—	JXD62B225	JXD63B225
	250	1250	1430	1610	1790	1960	2140	2320	2500	—	JXD62B250	JXD63B250
	300	1250	1430	1610	1790	1960	2140	2320	2500	—	JXD62B300	JXD63B300
	350	2000	2290	2570	2860	3140	3430	3710	4000	—	JXD62B350	JXD23B350
	400	2000	2290	2570	2860	3140	3430	3710	4000	—	JXD62B400	JXD23B400
JD6(A)	200	1250	1430	1610	1790	1960	2140	2320	2500	—	JD62B200	JD63B200
	225	1250	1430	1610	1790	1960	2140	2320	2500	—	JD62B225	JD63B225
	250	1250	1430	1610	1790	1960	2140	2320	2500	—	JD62B250	JD63B250
	300	1250	1430	1610	1790	1960	2140	2320	2500	—	JD62B300	JD63B300
	350	2000	2290	2570	2860	3140	3430	3710	4000	—	JD62B350	JD63B350
	400	1250	1430	1610	1790	1960	2140	2320	2500	JXD63L400 JXD63H400	—	—
HJD6(A)	200	1250	1430	1610	1790	1960	2140	2320	2500	—	HJD62B200	HJD63B200
	225	1250	1430	1610	1790	1960	2140	2320	2500	—	HJD62B225	HJD63B225
	250	1250	1430	1610	1790	1960	2140	2320	2500	—	HJD62B250	HJD63H250
	300	1250	1430	1610	1790	1960	2140	2320	2500	—	HJD62B300	HJD63B300
	350	2000	2290	2570	2860	3140	3430	3710	4000	—	HJD62B350	HJD63B350
	400	2000	2290	2570	2860	3140	3430	3710	4000	—	HJD62H400	HJD63B400
HHJD6	200	1250	1430	1610	1790	1960	2140	2320	2500	—	HHJD62B200	HHJD63B200
	225	1250	1430	1610	1790	1960	2140	2320	2500	—	HHJD62B225	HHJD63B225
	250	1250	1430	1610	1790	1960	2140	2320	2500	—	HHJD62B250	HHJD63B250
	300	1250	1430	1610	1790	1960	2140	2320	2500	—	HHJD62B300	HHJD63B300
	350	2000	2290	2570	2860	3140	3430	3710	4000	—	HHJD62B350	HHJD63B350
	400	2000	2290	2570	2860	3140	3430	3710	4000	—	HHJD62B400	HHJD63B400
CJD6	200	1250	1430	1610	1790	1960	2140	2320	2500	—	—	CJD63B200
	225	1250	1430	1610	1790	1960	2140	2320	2500	—	—	CJD63B225
	250	1250	1430	1610	1790	1960	2140	2320	2500	—	—	CJD63B250
	300	1250	1430	1610	1790	1960	2140	2320	2500	—	—	CJD63B300
	350	2000	2290	2570	2860	3140	3430	3710	4000	—	—	CJD63B350
	400	2000	2290	2570	2860	3140	3430	3710	4000	CJD63H400 CJD63L400	—	CJD63B400
LXD6(A)	450	2000	2290	2570	2860	3140	3430	3710	4000	—	LXD62B450	LXD63B450
	500	3000	3430	3860	4290	4710	5140	5570	6000	—	LXD62B500	LXD63B500
	600	3000	3430	3860	4290	4710	5140	5570	6000	—	LXD62B600	LXD63B600
LD6(A)	250	1250	1430	1610	1790	1960	2140	2320	2500	—	LD62B250	LD63B250
	300	1250	1430	1610	1790	1960	2140	2320	2500	—	LD62B300	LD63B300
	350	2000	2290	2570	2860	3140	3430	3710	4000	—	LD62B350	LD63B350
	400	2000	2290	2570	2860	3140	3430	3710	4000	—	LD62B400	LD63B400
	450	2000	2290	2570	2860	3140	3430	3710	4000	—	LD62B450	LD63B450
	500	3000	3430	3800	4290	4710	5140	5570	6000	—	LD62B500	LD63B500
HLD6(A)	250	1250	1430	1610	1790	1960	2140	2320	2500	—	—	—
	300	1250	1430	1610	1790	1960	2140	2320	2500	—	—	—
	350	2000	2290	2570	2860	3140	3430	3710	4000	—	—	—
	400	2000	2290	2570	2860	3140	3430	3710	4000	—	—	—
	450	2000	2290	2570	2860	3140	3430	3710	4000	—	—	—
	500	3000	3430	3860	4290	4710	5140	5570	6000	—	—	—
HHLD6	250	1250	1430	1610	1790	1960	2140	2320	2500	—	—	—
	300	1250	1430	1610	1790	1960	2140	2320	2500	—	—	—
	350	2000	2290	2570	2860	3140	3430	3710	4000	—	—	—
	400	2000	2290	2570	2860	3140	3430	3710	4000	—	—	—
	450	2000	2290	2570	2860	3140	3430	3710	4000	—	—	—
	500	3000	3430	3860	4290	4710	5140	5570	6000	—	—	—
CLD6	250	1250	1430	1610	1790	1960	2140	2320	2500	—	—	CJD63B250
	300	1250	1430	1610	1790	1960	2140	2320	2500	—	—	CJD63B300
	350	2000	2290	2570	2860	3140	3430	3710	4000	—	—	CJD63B350
	400	2000	2290	2570	2860	3140	3430	3710	4000	—	—	CJD63B400
	450	2000	2290	2570	2860	3140	3430	3710	4000	—	—	CLD63B450
	500	3000	3430	3860	4290	4710	5140	5570	6000	—	—	CLD63B500
LMXD6	500	3000	3430	3860	4290	4710	5140	5570	6000	—	—	—
	600	3000	3430	3860	4290	4710	5140	5570	6000	—	—	—
	700	3200	3500	3700	4200	4700	6400	7300	8000	—	—	—
	800	2800	3100	3400	3700	4000	4800	5500	6000	—	—	—
	800	3200	3500	3700	4200	4700	6400	7300	8000	—	—	—
	800	3000	3430	3860	4290	4710	5140	5570	6000	—	—	—
LMD6	500	3000	3430	3860	4290	4710	5140	5570	6000	—	—	—
	600	3000	3430	3860	4290	4710	5140	5570	6000	—	—	—
	700	3200	3500	3700	4200	4700	6400	7300	8000	—	—	—
	800	3200	3500	3700	4200	4700	6400	7300	8000	—	—	—
	800	3000	3430	3860	4290	4710	5140	5570	6000	—	—	—
	800	3000	3430	3860	4290	4710	5140	5570	6000	—	—	—

Sentron Molded Case Circuit Breakers

Adjustable Instantaneous Magnetic Trip Settings

Application

Breaker Type	Maximum Continuous Amperes	Nominal AC Adjustable Trip Range								ETI Motor Circuit Protector Catalog Number	Thermal Magnetic Catalog Number	
		Low	2	3	4	5	6	7	High		3-Pole	2-Pole
HLMXD6	500	3000	3430	3860	4290	4710	5140	5570	6000	—	—	HLMXD63B500
	600	3000	3430	3860	4290	4710	5140	5570	6000	—	—	HLMXD63B600
	700	3200	3500	3700	4200	4700	6400	7300	8000	—	—	HLMXD63B700
	800	3200	3500	3700	4200	4700	6400	7300	8000	—	—	HLMXD63B800
HLMD6	500	3000	3430	3860	4290	4710	5140	5570	6000	—	HLMD62B500	HLMD63B500
	600	3000	3430	3860	4290	4710	5140	5570	6000	—	HLMD62B600	HLMD63B600
	700	3200	3500	3700	4200	4700	6400	7300	8000	—	HLMD62B700	HLMD63B700
	800	3200	3500	3700	4200	4700	6400	7300	8000	—	HLMD62B800	HLMD63B800
MD6	500	3000	3430	3860	4290	4710	5140	5570	6000	—	MD62B500	MD63B500
	600	3000	3430	3860	4290	4710	5140	5570	6000	—	MD62B600	MD63B600
	700	4000	4570	5140	5710	6280	6850	7420	8000	—	MD62B700	MD63B700
	800	3000	3430	3860	4280	4710	5140	5570	6000	MXD63L800	—	—
	800	4000	4570	5140	5710	6280	6850	7420	8000	MXD63A800	MD62B800	MD63B800
	800	5000	5715	6430	7145	7860	8575	9290	10000	MXD63H800	—	—
MXD6	500	3000	3430	3860	4280	4710	5140	5570	6000	—	MXD62B500	MXD63B500
	600	3000	3430	3860	4280	4710	5140	5570	6000	—	MXD62B600	MXD63B600
	700	4000	4570	5140	5710	6280	6850	7420	8000	—	MXD62B700	MXD63B700
	800	3000	3430	3860	4280	4710	5140	5570	6000	MXD63L800	—	—
	800	4000	4570	5140	5710	6280	6850	7420	8000	MXD63A800	MXD62B800	MXD63B800
	800	5000	5715	6430	7145	7860	8575	9290	10000	MXD63H800	—	—
HMD6	500	3000	3430	3860	4280	4710	5140	5570	6000	—	HMD62B500	HMD63B500
	600	3000	3430	3860	4280	4710	5140	5570	6000	—	HMD62B500	HMD63B600
	700	4000	4570	5140	5710	6280	6850	7420	8000	—	HMD62B700	HMD63B700
	800	4000	4570	5140	5710	6280	6850	7420	8000	—	HMD62B800	HMD63B800
HMXD6	500	3000	3430	3860	4280	4710	5140	5570	6000	—	—	HMXD63B500
	600	3000	3430	3860	4280	4710	5140	5570	6000	—	—	HMXD63B600
	700	4000	4570	5140	5710	6280	6850	7420	8000	—	—	HMXD63B700
	800	4000	4570	5140	5710	6280	6850	7420	8000	—	—	HMXD63B800
CMD6	400	3000	3430	3860	4280	4710	5140	5570	6000	—	—	—
	500	3000	3430	3860	4280	4710	5140	5570	6000	—	—	—
	600	3000	3430	3860	4280	4710	5140	5570	6000	—	—	CMD63B600
	700	4000	4570	5140	5710	6280	6850	7420	8000	—	—	CMD63B700
	800	3000	3430	3860	4280	4710	5140	5570	6000	CMD63L800	—	—
	800	4000	4570	5140	5710	6280	6850	7420	8000	CMD63A800	—	CMD63B800
	800	5000	5715	6430	7145	7860	8575	9290	10000	CMD63H800	—	—
	800	5000	5715	6430	7145	7860	8575	9290	10000	—	—	—
ND6	800	4000	4570	5140	5710	6280	6850	7420	8000	—	ND62B800	ND63B800
	900	5000	5715	6430	7145	7860	8575	9290	10000	—	ND62B900	ND63B900
	1000	5000	5715	6430	7145	7860	8575	9290	10000	—	ND62B100	ND63B100
	1200	5000	5715	6430	7145	7860	8575	9290	10000	—	ND62B120	ND63B120
NXD6	900	5000	5715	6430	7145	7860	8575	9290	10000	—	NXD62B900	NXD63B900
	1000	5000	5715	6430	7145	7860	8575	9290	10000	—	NXD62B100	NXD63B100
	1200	5000	5715	6430	7145	7860	8575	9290	10000	—	NXD62B120	NXD63B120
HND6	800	4000	4570	5140	5710	6280	6850	7420	8000	—	HND62B800	HND63B800
	900	5000	5715	6430	7145	7860	8575	9290	10000	—	HND62B900	HND63B900
	1000	5000	5715	6430	7145	7860	8575	9290	10000	—	HND62B100	HND63B100
	1200	5000	5715	6430	7145	7860	8575	9290	10000	—	HND62B120	HND63B120
HNXD6	900	5000	5715	6430	7145	7860	8575	9290	10000	—	—	HNXD63B900
	1000	5000	5715	6430	7145	7860	8575	9290	10000	—	—	HNXD63B100
	1200	5000	5715	6430	7145	7860	8575	9290	10000	—	—	HNXD63B120
CND6	800	4000	4570	5140	5710	6280	6850	7420	8000	—	—	CND63B800
	900	5000	5715	6430	7145	7860	8575	9290	10000	—	—	CND63B900
	1000	5000	5715	6430	7145	7860	8575	9290	10000	—	—	CND63B100
	1200	5000	5715	6430	7145	7860	8575	9290	10000	—	—	CND63B120
PD6	1200	5000	5715	6430	7145	7860	8575	9290	10000	—	—	PD63B120
	1400	5000	5715	6430	7145	7860	8575	9290	10000	—	—	PD63B140
	1600	5000	5715	6430	7145	7860	8575	9290	10000	—	—	PD63B160
PXD6	1200	5000	5715	6430	7145	7860	8575	9290	10000	—	—	PXD63B120
	1400	5000	5715	6430	7145	7860	8575	9290	10000	—	—	PXD63B140
	1600	5000	5715	6430	7145	7860	8575	9290	10000	—	—	PXD63B160
HPD6	1200	5000	5715	6430	7145	7860	8575	9290	10000	—	—	HPD63B120
	1400	5000	5715	6430	7145	7860	8575	9290	10000	—	—	HPD63B140
	1600	5000	5715	6430	7145	7860	8575	9290	10000	—	—	HPD63B160
HPXD6	1200	5000	5715	6430	7145	7860	8575	9290	10000	—	—	HPXD63B120
	1400	5000	5715	6430	7145	7860	8575	9290	10000	—	—	HPXD63B140
	1600	5000	5715	6430	7145	7860	8575	9290	10000	—	—	HPXD63B160
CPD6	1200	5000	5715	6430	7145	7860	8575	9290	10000	—	—	CPD63B120
	1400	5000	5715	6430	7145	7860	8575	9290	10000	—	—	CPD63B140
	1600	5000	5715	6430	7145	7860	8575	9290	10000	—	—	CPD63B160
RD6	1800	5000	5715	6430	7145	7860	8575	9290	10000	—	—	RD63B180
	2000	5000	5715	6430	7145	7860	8575	9290	10000	—	—	RD63B200
RXD6	1800	5000	5715	6430	7145	7860	8575	9290	10000	—	—	RXD63B180
	2000	5000	5715	6430	7145	7860	8575	9290	10000	—	—	RXD63B200
HRD6	1800	5000	5715	6430	7145	7860	8575	9290	10000	—	—	HRD63B180
	2000	5000	5715	6430	7145	7860	8575	9290	10000	—	—	HRD63B200
HRXD6	1800	5000	5715	6430	7145	7860	8575	9290	10000	—	—	HRXD63B180
	2000	5000	5715	6430	7145	7860	8575	9290	10000	—	—	HRXD63B200

Sentron Molded Case Circuit Breakers

Molded Case Switch — Circuit Disconnect

Selection

Maximum Frame Amp Rating	2-Pole	3-Pole	Self-Protective Instantaneous Override $\pm 20\%$ ③
	Catalog Number	Catalog Number	
100	BQ2S060■ BQ2S100■	BQ3S060■ BQ3S100■	1000 1000
125	ED22S100A■ ED42S100A■ ED42S125A■ ED62S100A■ — CED62S100A■ CED62S125A■ — —	ED23S100A ED43S100A ED43S125A ED63S100A ED63S125A CED63S100A■ CED63S125A■ HES3S100L HES3S125L	1000 1000 1000 1000 1000 1000 1000 1250 1250
225	QJ22S225A■	QJ23S225A	2000
250	FXD62S250A HFXD62S250A■ ①	FXD63S250A HFXD63S250A■ CFD63S250A■	3200 3200 3200
400	JXD22S400A■ — — ①	JXD23S400A JXD63S400A HJXD63S400A■ CJD63S400A■	6000 6000 6000 6000
600	— — ①	LXD63S600A HLXD63S600A■ CLD63S600A■	6000 6000 6000
800	— — ①	LMXD63S800A■ MXD63S800A CMD63S800A	8000 8000 8000
1200	— ①	NXD63S120A CND63S120A■	10000 10000
1600	①	PXD63S160A⑤	10000
2000	①	RXD63S200A■⑤	10000

Ordering Information

Order by catalog number. Switches include frame and self protective trip unit only. Order lugs separately from pages 17/101 to 17/103.

■ Built to order. Allow 2–3 weeks for delivery.

① For 2-pole application use outside poles of 3-pole circuit breaker.

② For additional lugs see pages 17/101 to 17/103.

③ Molded case switches up to R frame contain a self protecting instantaneous element, which may open circuit above their override set point.

④ UL file E57556 Volume 1, section 2 and CSA LR 42022-51.

⑤ Requires mounting block MB9301 or MBR9302.

Lugs pages 17/101 to 17/103
Accessories pages 17/108 to 17/113

Sentron Molded Case Circuit Breakers

Digital Solid State Sentron Sensitrip III Series

Technical

The Sentron Sensitrip III circuit breaker is a true RMS current sensing device. Digital microprocessor circuitry within the electronic trip unit provides more precise control over the circuit breaker functions. This control allows circuit coordination flexibility not available with thermal magnetic circuit breakers.

Functions available in Sentron Sensitrip circuit breakers

Catalog Number (Description + Suffix)	Trip Type	Cont Current Setting	Long Time Delay	Instantaneous Setting	Short Time Pick Up	Short Time Delay	Short Time I ² t Pick Up	Ground Fault Pick Up	Ground Fault Delay
Basic Unit + (A)	LI	✓	✓	✓					
Basic Unit + (A)G	LIG	✓	✓	✓				✓	✓
Basic Unit + (A)NT	LSI	✓	✓	✓	✓	✓	✓		
Basic Unit + (A)NGT	LSIG	✓	✓	✓	✓	✓	✓	✓	✓

Letter "A" is used for MD and ND Solid State frame types only.

Typical Trip Unit Labeling and Adjustment Positions for the Sentron Sensitrip Circuit Breaker.

SMD6, SHMD6, SCMD6, SND6, SHND6, SCND6, SPD6, SHPD6

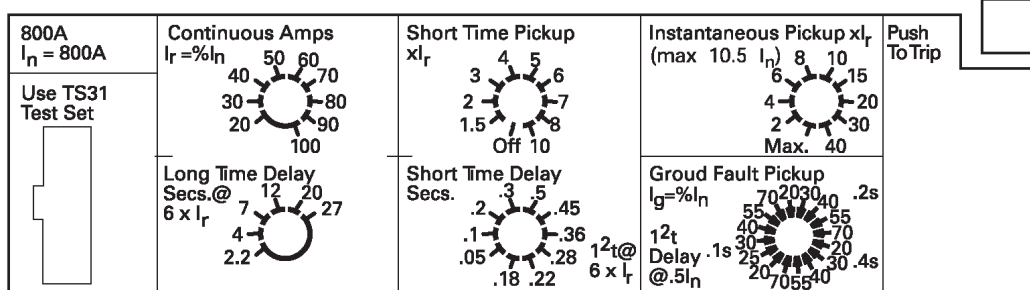

SJD6, SHJD6, SCJD6, SCD6, SHLD6, SCLD6

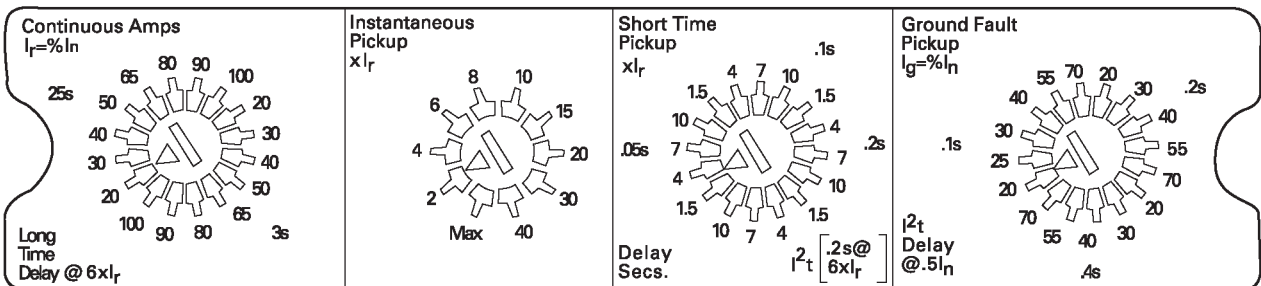

I_n = Maximum circuit breaker ampere rating.

I_r = Current Rating — a function of continuous ampere adjustment setting expressed in % of I_n .

I_g = Ground Fault Pickup — a function of adjustment setting expressed in % of I_n .

Sentron Molded Case Circuit Breakers

Digital Solid State Sentron Sensitrip III Series

Technical

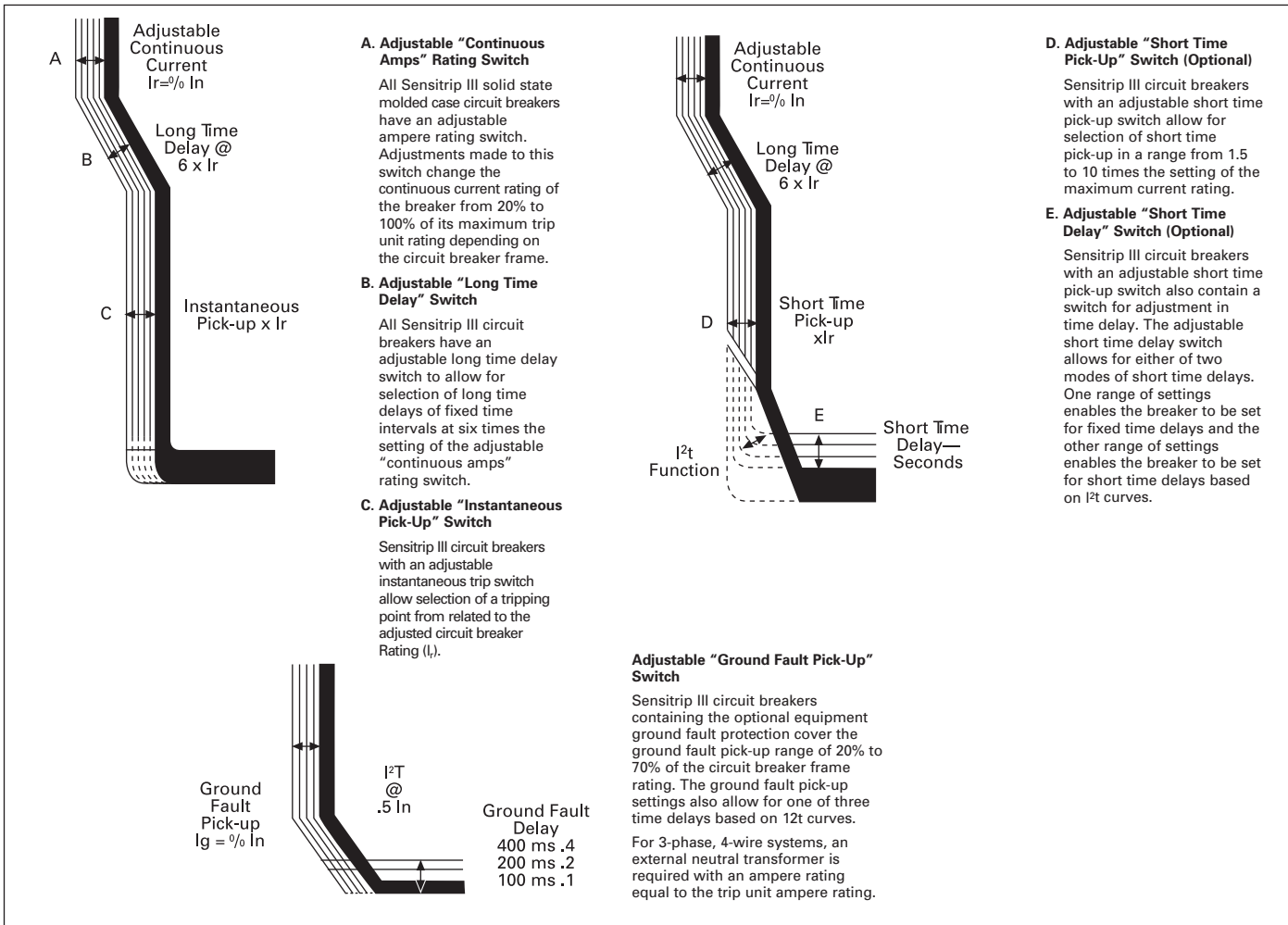

I_n = Maximum circuit breaker ampere rating.

I_r = Current Rating — a function of adjustment setting expressed in % of I_n .

I_g = Ground Fault Pick-up — a function of adjustment setting expressed in % of I_n .

Examples of Adjustment Settings

Catalog Number SMD69800A

$I_n = 800$	Continuous Current Setting	Long Time Delay Setting	Instantaneous Setting
$I_n = 800$ amperes Results	30 240 amperes $I_r = 30\%$ of 800	12 12 seconds trip at 6×240 amps = 1440.	8 1920 amperes $8 \times I_r = 8 \times 240$

Catalog Number SMD69800ANGT

I_n	I_r Setting	Long Time Delay	Short Time Pick-Up Off	Instantaneous Setting	Short Time Pick-Up On	Short Time Delay	I^2T Set	Ground Fault Pick-Up	Ground Fault Delay
800 amperes Results	70 560	20 20 sec.	—	$10 I_r$ 5600A	$8 I_r$ 4480A	.5 .5 secs	.28 .28 sec @ 4480A	40 320A	.2 .2 sec
Ⓐ	Ⓑ	Ⓒ	Ⓓ	Ⓔ	Ⓕ	Ⓖ	Ⓗ	Ⓚ	Ⓛ

Ⓐ $I_n = 800$ amperes.

Ⓑ $I_r = 560$ amperes (70% of 800).

Ⓒ Delay = 20 seconds at 3360 amps ($6 \times I_r$).
Breaker will trip in 20 seconds with 3360 amperes.

Ⓓ Short Time Pick-Up Off — Instantaneous can be used.

Ⓔ Instantaneous set at $10 \times I_r = 10 \times 560 = 5600$ amperes.

Ⓕ Short Time Pick-Up On — Set at $8 \times 8 \times 560 = 4480$ amperes.

Ⓖ Short Time Delay = .5 seconds. (Definite Time)

Note: Ⓒ & Ⓗ are mutually exclusive.

Ⓗ I^2t switch on .28 seconds at $6 \times 560 = 3360$ amperes. (Inverse time)

Ⓚ Ground Fault Pick-Up set at 40 = 40% of $I_n = 320$ amperes. (Definite Time)

Ⓛ Ground Fault Delay set at .2 seconds. Breaker will trip in 200 milliseconds with a 400 ampere ground fault.

Sentron Molded Case Circuit Breakers

Electronic and Communications Accessories

Selection

Multiplexor Translator

Breaker Type	Features	Catalog Number
SJD, SLD SMD, SND SPD	Zone Interlocking Only	MTZ
	Full Communications with Zone Interlocking	MTA

The Multiplexor Translator MTZ is an interface device required in zone selective interlock schemes. The MTA combines the zone selective interlocking function with interface to ACCESS® Systems.

Cables & Connectors

Ribbon Cables

Breaker Type	Length	Catalog Number
SJD, SLD	6"	EPC06
SMD, SND	8"	EPC08
SPD	12"	EPC12■
	18"	EPC18
	24"	EPC24■

Telephone Cables

Breaker Type	Length	Catalog Number
SJD, SLD	8'	MTC08
SMD, SND,	15'	MTC15
SPD	25'	MTC25
	50'	MTC50

Expansion Plug

Breaker Type	Frame Size	Mounting Type	Catalog Number
Sensitrip	ALL	ALL	EP

The Expansion Plug EP is a required isolating device to connect the breaker with the Multiplexor Translator. It is connected to the trip unit on the breaker with a "Ribbon Cable", EPC08 e.g., and the Multiplexor Translator with the "Telephone Cable" (an RJ-11 cable) MTC50 e.g.

Component Selection Guide^①

Trip Units and Application		
Component Type	ZSI (only) with Sensitrip MCCB'S	Access and/or ZSI with Sensitrip MCCB'S
EP	✓	✓
MTZ ^②	✓	
MTA ^②		✓
EPC Cable	✓	✓
MTC Cable ^③	✓	✓

■ Built to order. Allow 2-3 weeks for delivery.

▲ Built to order. Allow 6-8 weeks for delivery.

① When ordered with circuit breaker from the factory.

② One MTA or MTZ per eight trip units when required.

③ Always required when multiple MT's are used.

One additional cable per each additional MT.

Electronic & Display Devices

Trip Unit Test Set

Type	Catalog Number
SJD, SLD, SMD, SND, SPD, Portable	TS31
Spare TS-31 Test Set Interconnecting Cable	TS31CABLE

The TS-31 test set is used to test the operation of the fault protection functions of the circuit breaker's trip unit, including long-time, short-time, instantaneous, and ground fault by means of secondary current injections.

Sensitrip Ammeter Display Unit

Breaker Type	Catalog Number
SJD, SLD, SMD	SADU
SND, SPD	SADURMK18

The Sensitrip Ammeter Display Unit (SADU) provides real-time metering for all Sentron-Sensitrip III Molded Case Circuit Breakers. The unit plugs directly onto the front of the trip unit and provides displays for individual phase currents flowing through the breaker. Additional features include Average, Demand, Ground and Unbalance Current displays, along with impending Trip Status. Current Metering Logs, and a unique diagnostic Trip Log that records the date, time and type of fault for the previous five breaker trips. The device is UL and CSSA certified.

The optional panel mount accessory (SADURMK18) allows easy device mounting external from the circuit breaker, in panelboard and switchboard spaces or gutters, with the flexibility of interior panel exterior panel, or wall mounting capability.

The 2 x 16 alphanumeric LCD display provides easy viewing of data, such as viewing all three phase currents simultaneously.

SADU Ammeter Display Unit

- Direct plug-in or Panel Mounting*
- Trip Unit Powered & Battery back-up
- 2 x 16 LCD Alphanumeric Display*
- Ammeter Display Functions
 - RMS Phase Currents
 - Average Current*
 - Current Demand*
 - Ground Current
 - Current Unbalance (%)*
- Breaker Status
 - Normal
 - Impending Trip*
- Time Stamped Trip Log (last 5)
 - Time & Date*
 - Trip Cause: LT, ST, GF, SC
- Max Log (with date & time)
 - Max Phase Current*
 - Max Average Current*
 - Max Ground Current*
 - Max Unbalance Current*
 - Max Current Demand*

* Unique Features



For Use With Type(s)	Circuit Breaker Ampere Rating	Cables Per Lug	Lug Wire Range	Catalog Number
BQ, BQH, BQHF BQE, BQF, BL, BLH, HBL, HBQ Switching Neutrals BG, BLG	Line Side			
	15-40	1	#14-#6 AWG Cu #12-#6 AWG Al	TC1Q1 ^{①②}
	45-125	1	#8-#1 AWG Cu #6-#1/0 AWG Al	TA1Q1 ^②
	Load Side			
	15-20	1	#14-#10 AWG Cu #12-#10 AWG Al	Lugs are integral to Circuit Breaker
	25-35	1	#14-#6 AWG Cu #12-#6 AWG Al	
	40-50	1	#8-#6 AWG Cu #8-#4 AWG Al	
	55-70	1	#8-#4 AWG Cu #8-#2 AWG Al	
	80-100	1	#4-#1/0 AWG Cu #2-#1/0 AWG Al	
	110-125	1	#2-#1/0 AWG Cu	
1		#1/0-#2/0 AWG Al		
BQD, CQD BQD6, CQD6	Line Side (CQD, CQD6) & Load Side			
	15-40	1	#14-#6 AWG Cu #12-#6 AWG Al	Integral
	45-100	1	#8-#1 AWG Cu #6-#1/0 AWG Al	Integral
NGG, HGG, LGG	15-30	1	#14-#6 AWG Cu #12-#6 AWG Al	TC1Q1
	15-30	1	#14-#6 AWG Cu #12-#6 AWG Al	3TC1Q1 (pkg. of 3)
	35-125	1	#8-#1/0 AWG Cu #8-#2/0 AWG Al	3TC1GG20 (pkg. of 3)
	15-125	—	NUT KEEPER PLATE	TNKG3 ^③ (pkg. of 3)
NEG, HEG	15-125	1	#14-3/0 AWG Cu	3TW1EG30 (pkg. of 3)
	15-125	1	#14-1/0 AWG Cu/Al	3TA1EG10 (pkg. of 3)
	15-125	1	#6-3/0 AWG Cu/Al	3TA1EG30 (pkg. of 3)
	15-125	—	Nut Keeper Kit (3-pole)	TNKE3 (pkg. of 3)
	15-125	—	Nut Keeper Kit (4-pole)	TNKE4 (pkg. of 4)

Connector wire ranges and cavities are established in conjunction with Table 6.1.4.2.1 of UL 489 standards.

Note:

(A) Molded case circuit breakers having a rated ampacity of 125 amperes or less are to be connected with 60 or 75°C wire. Circuit breakers having a rated ampacity greater than 125 amperes shall only be cabled with 75°C cable unless otherwise indicated on the circuit breaker label. Exceptions to this rule are outlined in article 110-14 C(1)(2) of the 2005 National Electrical Code.

(B) Connector wire ranges and cavities are established in conjunction with Table 6.1.4.2.1 of UL 489 standards.

- ① Lug is steel.
- ② Sold in package of six.
- ③ One nut keeper plate is required with each lug on the NGG breaker.

Lug information

Aluminum Body Lugs for Copper or Aluminum Wire

Selection

For Use With Type(s)	Circuit Breaker Ampere Rating	Cables Per Lug	Lug Wire Range	Catalog Number
QJ2, QJH2, QJ2H, HQJ2, HQJ2H	60–225	1	#6 AWG–300 kcmil (Cu) #4 AWG–300 kcmil (Al)	TA1Q300 (pkg. of 3)
All 2, 3-pole ED2, ED4, ED6, ED6 ETI, HED4, HHED6	15–25	1	#14–#10 AWG (Cu) #12–#10 AWG (Al)	SA1E025
	30–100	1	#10–#1/0 (Cu or Al)	LN1E100
	110–125	1	#3-3/0 (Cu) #1-2/0 (Al)	TA1E6125
CED6 All 1-pole ED, HED	30–60	1	#10–4 (Cu or Al)	LD1E060 (Load Side)
	70–100	1	#4–#1/0 (Cu or Al)	LD1E100 (Load Side)
FXD6-A, FD6-A, HFD6, CFD6 HHFD6	70–250	1	#6 AWG–350 kcmil (Cu) #4 AWG–350 kcmil (Al)	TA1FD350A
SJD6(A), SHJD6(A) SCJD6	65-200	1–2	#4 AWG–3/0 (Cu or Al)	TA2J630
JXD2(A), JXD6(A), JD6(A), SJD6(A), HJD6(A), HJXD6(A) HHJXD6, HHJD6, SHJD6(A), CJD6, SCJD6	200–400	1–2	3/0–500 kcmil (Cu) 4/0–500 kcmil (Al)	TA2J6500
LXD6(A), LD6(A), SLD6(A), HLD6(A), HLXD6(A), HHLXD6, HHLD6, SHLD6(A), CLD6, SCLD6	250–600	1–2	3/0–500 kcmil (Cu) 4/0–500 kcmil (Al)	TA2J6500
LMD6 ^① , LMXD6 ^① , HLMD6 ^② , HLMXD6 ^② , MD6, MXD6, SMD6, HMD6, HMXD6, SHMD6, CMD6, SCMD6	500–600	1–2	#1–500 kcmil (Cu or Al)	TA2K500
		1–3	1/0–500 kcmil (Cu or Al)	TA3K500
	500–800	1–2	500–750 kcmil (Cu or Al)	TA2N750 ^②
ND6, NXD6, SND6, HND6, HNXD6, SHND6, CND6, SCND6	800–1200	1–4	250–500 kcmil (Cu or Al)	2TA4P8500 ^{②③} 3TA4P8500 ^{②③}
			250–500 kcmil (Cu or Al)	2TA4N8500 ^③ 3TA4N8500 ^④
PD6, HPD6, CPD6 PXD6, HPXD6, SPD6, SHPD6	1200–1600	1–5	300–600 kcmil (Cu or Al)	TA5P600
PD6, PXD6, HPD6, HPXD6, SPD6, SHPD6, RD6, RXD6, HRD6, HRXD6, STD	1200–2000	1–6	300–600 kcmil (Cu or Al)	TA6R600

①Use TA2K500 or TA3K500 only.

②Used for 100% rated MD/ND frame breakers.
Rated for 90° C cable.

③Contains 2 connectors plus 1 NDTs end barrier.

④Contains 3 connectors plus 1 NDTs end barrier.

• Revised •
07/20/14

Lug information

Optional Mechanical Lugs

Selection

For Use With Type	Circuit Breaker Ampere Rating	Cables Per Lug	Lug Material	Lug Wire Range	Qty Per Catalog No	Catalog Number
QJ2, QJH2, QJ2H, HQJ2, HQJ2H	60-225	1	Cu	#6 AWG-250 kcmil (Cu)	3	TC1Q250
ED, HED 1, 2 & 3-pole	1, 2 & 3-pole 30-125	1	Cu	#10-#1/0 (Cu)	1	TC1ED6150
HFD6, HHFD6, CFD6, F(X)D6-A	70-250	1	Cu	#6 AWG-350 kcmil (Cu)	1	TC1FD350
J(X)D2(A), J(X)D6(A), HJD6(A), HHJD6, SHJD6(A), L(X)D6(A), HHL6, SCD6, HLD6(A), SHLD6(A), CJD6, CLD6, SCJD6, SCLD6	200-600	1 1-2	Cu	3/0-600 kcmil (Cu) 3/0-500 kcmil (Cu)	1 1	TC1J6600 [Ⓢ] TC2J6500 [Ⓢ]
	250-600	1 1	Al	500-750 kcmil (Al) 500-600 kcmil (Cu)	1	TA1L6750
SMD6, M(X)D6, HM(X)D6, HMD6, CMD6, SCMD6, SND6, N(X)D6, HN(X)D6, SHND6, CND6, SCND6	500-600	1-2	Cu	#1 AWG-500 kcmil (Cu)	1	TC2K500
	700-800	1-3	Cu	#1 AWG-350 kcmil (Cu)	1	TC3K350
		1-2	Al	500-750 kcmil (Cu) 500-750 kcmil (Al)	2 3	2TA2N8750 3TA2N8750
800-1200	1-3	Al	500-750 kcmil (Cu) 500-750 kcmil (Al)	2 3	2TA3N8750 3TA3N8750	
R(X)D6, HR(X)D6	1600-2000	1-5	Cu	300-600 kcmil (Cu)	1	TC5R600
P(X)D6, HP(X)D6, CPD6, SPD6, SHPD6	1200-1600	1-4	Al	600-750 kcmil (Cu/Al)	1	TA4P750▲

Compression Lugs

For Circuit Breaker Types	Ampere Rating	Poles	Lugs Per Kit	Lug Wire Size	Catalog Number	
Lugs (contains indicated number of lugs and necessary hardware per kit)						
ED2, ED4, ED6, HED4, HHED6, CED6	15-125	1, 2, 3	1	#2/0 AWG Cu/Al	CCE125	
QJ2, QJH2, QJ2-H	125-225	2, 3	1	350 kcmil Cu/Al	CCQ225	
F(X)D6-A, HF(X)D6, HHF(X)D6, CFD6	125-250	2, 3	1	350 kcmil	CCF250	
JXD2-A, J(X)D6-A, HJ(X)D6-A, HHJ(X)D6-A, CJD6, SJD6-A, SHJD6-A, SCJD6, L(X)D6-A, HL(X)D6-A, CLD6, SLD6-A, SHLD6-A, SCLD6	200-600	2, 3	1	500 kcmil	CCL600	
Kits (contain lugs and hardware for complete line or load end of 2 or 3-pole breaker)						
M(X)D6, HM(X)D6, CMD6, SMD6, SHMD6, SCMD6	500-800		2	6	500 kcmil	CCM800K2
			3	9		CCM800K3
N(X)D6, HN(X)D6, CND6, SND6, SHND6, SCND6	900-1200		2	8	500 kcmil	CCN1200K2
			3	12		CCN1200K3

Distribution Lugs[Ⓢ]

For Circuit Breaker Types	Ampere Rating	Poles	Lugs Per kit	Wires Per Lug	Lug Wire Size	Catalog Number
NGG, HGG, LGG	15-125	1,2,3	1	6	#6-#4 AL #14-#4 Cu	TA6GG04
NEG, HEG	15-125	1,2,3	3	3	#14-#2 AWG Cu	3TA3EG02
NEG, HEG	15-125	1,2,3	3	6	#14-#6 AWG Cu	3TA6EG06
ED2, ED4, ED6, HED4, HHED6, CED6	15-125	1,2,3	1	6	#14-#4 AWG Cu #6-#4 AWG Al	TA6ED06
F(X)D6-A, HF(X)D6, HHF(X)D6, CFD6	70-250	2,3	1	6	#14-#4 AWG Cu #6-#4 AWG Al	TA6FD04
JXD2-A, J(X)D6-A, HJ(X)D6-A, HHJ(X)D6-A, CJD6-A, SJD6, SHJD6-A, SCJD6, L(X)D6-A, HL(X)D6-A, CLD6-A, SLD6-A, SHLD6-A, SCLD6	200-600	2,3	1	6	#14-2/0 AWG Cu #6-2/0 AWG Al	TA6JD20

▲ Built to order. Allow 6-8 weeks for delivery.

Ⓢ Used for 100% rated JD/LD frame circuit breakers.

Ⓢ Special purpose wire connectors, not for general use.

General Selection

A variety of internal and external accessories, as well as modifications, are available to adapt Siemens circuit breakers to special installation requirements. UL listed internal accessories for 100 through 2000A circuit breakers are field-addable.

Internal accessories fine tune an electrical distribution system, allowing control of the circuit breakers to meet special application requirements. For example, emergency situations may dictate tripping critically placed circuit breakers quickly. Shunt trips accomplish this conveniently and efficiently. Or, when voltage drops are a concern, undervoltage trips automatically open the circuit breaker at a predetermined voltage level.

A wide range of external operating and mounting accessories is also available. For example, face, shallow, and back mounting plates are ideal for tailoring BQ circuit breakers to OEM applications. A complete line of operating handles and handle-blocking devices meet switchboard, enclosure and safety needs. Plug-in mounting assemblies, which simplify switchboard mounting of circuit breakers and permit breaker removal without disconnecting bus or cable connections, are available.

UL 489 Supplement SB Naval Use Breakers

Breakers tested to UL 489 Supplement SB are qualified for use on non combat and auxiliary naval vessels.

Siemens molded case breakers, including BL, NGB and Sentron ED through RD frames can be labeled "NAVAL" in compliance with UL 489 Supplement SB.

Supplement SB testing comprises two sets of vibration tests. The first is to find mechanical resonances in the product and to subject the breaker to extreme testing at each resonant frequency. The second is a swept frequency test, in which the frequency of excitation is changed in intervals of 1Hz, and held at each frequency for five minutes. The excitation frequencies run from 4 to 33Hz, and the test is conducted in each of the three orthogonal axes of the breaker.

During these tests, the breaker must not trip from the closed position, nor may the contacts touch from the open position. Calibration and insulation resistance are also verified during the test.

For detailed information, refer to UL 489, Supplement SB.

50°C Ambient Calibration — Not UL listed and not available for solid state, 100% rated breakers or 400HZ calibrated breakers.

- For BL Type Circuit Breakers
 - Add suffix 'M' to catalog number
(Example: B120M).....No Charge
- For BQ, QJ2, and ED Frame Circuit Breakers
 - Replace 'B' in catalog number with 'M'.....No Charge
(Example: BQ3M060, QJ23M200, ED63M060)
- For FD, JD, LD, LMD, MD, ND, PD, and RD Frame Circuit Breakers
 - Non-Interchangeable Trip (3-pole only)No Charge
 - Replace 'B' in catalog number with 'M'
(Example: FXD63M225, JXD63M400)

400 HZ Calibration

- UL Listed (5KA IR)
 - For BQ & BL Type Circuit Breakers (200A max.).....Add 25% to list price
 - Add suffix 'Y' to catalog number
- Not UL Listed
For all other Circuit Breakers, see derating tables on page 6-152 and order standard circuit breakers.

Fungus Proofing

- All BQD, CQD, GB, GG, ED, FD, JD, LD, LMD, MD, ND, PD, RD, DG, FG, JG, LG, MG, NG, and PG Frame Circuit Breakers are inherently fungus resistant and do not require special treatment.
- For BL, and BQ Type Circuit Breakers.....Add \$10.00 net per pole
 - Consult Sales Office for Availability
- For all other Circuit Breaker Types.....Add \$160.00 net per device
 - Consult Sales Office for Availability

Certificate of Compliance with Test Report (catalog number CERT OF COMP.) Add \$210.00 net
Certificate of compliance testing must be performed on the actual device being shipped. The certificate cannot be provided after initial shipment. Order for devices with COC requirement must be placed directly with the factory by the sales office and shipped directly to the end user.

Ordering Information

For "NAVAL" label, add **\$75.** net per catalog number per order. Order must be placed directly with the factory by Siemens Sales Office.

Types	UL File
BQD/CQD	E10848, Vol 10, Sec 1
GG	E10848, Vol 10, Sec 2
GB	E10848, Vol 10, Sec 3
ED2, ED4, IED4, HED6	E10848, Vol 4, Sec 11
CED6	E10848, Vol 4, Sec 13
FD6, FXD6, HFD6, HFXD6	E10848, Vol 4, Sec 17
CFD6	E10848, Vol 4, Sec 18
JXD2, JD6, JXD6, LXD6, LD6, HJD6, HJXD6, HLD6, HLXD6	E10848, Vol 4, Sec 8
HHJD6, HHJXD6, HHLD6, HHLXD6	E10848, Vol 4, Sec 20
CJD6, CLD6	E10848, Vol 4, Sec 14
MD6, MXD6, HMD6, HMXD6, CMD6, ND6, NXD6, HND6, HNXD6, CND6	E10848, Vol 4, Sec 15
PD6, PXD6, HPD6, HPSXD6, CPD6, RD6, RXD6, HRD6, HRXD6	E10848, Vol 4, Sec 19

Molded Case Circuit Breakers

Internal Accessories

General

Feature Combinations

The available feature combinations are shown in the chart below. For applications requiring combinations of features not listed in this chart, consult the sales office for availability.

Breakers	Modules Per Breaker	Avail. On Breaker Poles	ST	ST/AUX	ST/ALSW	ST/AUX/ALSW	UVT	UVT/AUX	UVT/ALSW	UVT/AUX/ALSW	AUX	AUX/ALSW	ALSW	Elect. Bell Alarm	Ground fault	Grd fault w/Bell
QP, BQ, BL ^①	1	1, 2, 3	1	—	—	—	—	—	—	—	1, 2	—	—	—	—	—
BQD, CQD, GB, GG	1	2, 3	1	1/1	—	—	—	—	—	—	1, 2	1/1	1	—	—	—
QJ ^②	1	3	1	1/1	—	—	—	—	—	—	2	—	—	—	—	—
All ED	1	1, 2, 3	1	1/1, 1/2	1/1	1/1/1	1	1/1, 1/2	1/1	1/1/1	1, 2	1/1, 2/1	1	—	1	1
All FD	2	2, 3	1	—	—	—	1	1/1	—	—	1, 2	1/1	1	—	—	—
All JD, LD, LMD ^②	2	2, 3	1	1	—	—	1	1/1, 1/2	—	—	1, 2	1/1, 1/2	1, 2	—	—	—
SJD6, SHJD6, SCJD6, SLD6, SHLD6, SCLD6 ^③	1	3	1	1	—	—	1	1/1, 1/2	—	—	1, 2	1/1, 1/2	1, 2	—	—	—
All MD, ND, PD, RD Including Electronic trip ^④	2	2, 3	1	1/1	—	—	1	1/1, 1/2	—	—	1, 2	1/1, 2/1	1, 2	—	—	—
STD ^⑤	6	3	1	—	—	—	1	—	—	—	1 NC / 1 NO, 2 NC / 2 NO, 3 NC / 3 NO, 4 NC / 4 NO, 5 NC / 5 NO, 6 NC / 6 NO	—	1	1	—	—

Shunt Trip (ST)

One or all critical circuit breakers may be tripped from a distant control point by use of a shunt trip device. A shunt trip operates through an auxiliary switch contact; when the breaker opens, current is not maintained on the shunt trip coil.

Undervoltage Trip (UVT)

When voltage drops to a value below 35% of the nominal coil rating, the undervoltage trip device automatically opens the breaker. The operation is instantaneous, and the circuit breaker cannot be reclosed until the

voltage returns to 85% of line voltage. The undervoltage trip, which is continuously energized, must be energized before the circuit breaker can be closed.

Auxiliary Switch (AUX)

For applications requiring remote "on" or "off" indication (or electrical interlocking), auxiliary switches are available. Each switch comprises an "A" (open when circuit breaker is open) and a "B" (closed when circuit breaker is open) contact with a common connection. (Form C)

Alarm Switch (ALSW)

The alarm switch contact is closed when the circuit breaker is opened automatically by an overload, short circuit, shunt trip or undervoltage trip. The alarm switch contact is open when the circuit breaker is reset.

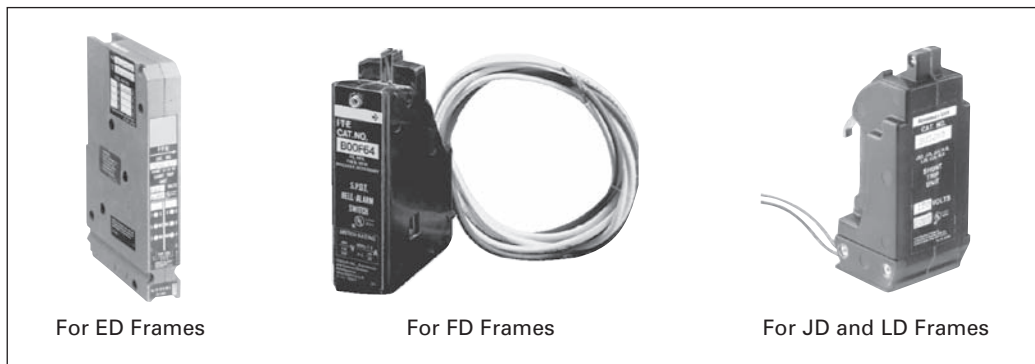

①Factory assembled only

②If mechanical interlock is installed, no accessory module can be installed in the right pocket.

③If mechanical interlock is installed, no accessory module can be installed.

④If mechanical interlock is installed, no accessory module can be installed in the left pocket.

⑤One module per column.

Circuit Breakers

Accessories

Circuit Breaker Accessories ④⑤⑥⑦⑧⑨

Catalog Number	For Use With Breaker Type	Number of Poles	Standard Package
Padlocking Device			
For locking breaker in "OFF" position. Note "ON" position does not affect breaker functionally			
ECPLD1	Type QP, BL, QAF, QPF, QE, QT-Duplex, BQ, BQXD	1P	3 Pieces
ECPLD2	Type QP, BL, QAF, QPF, QE, QT-Triplex & Quadplex, BQ, BQXD	2P	3 Pieces
ECPLD2R	Type QP, BL, QAF, QPF, QE, QT-Triplex & Quadplex, BQ, BQXD (Red Color)	2P	3 Pieces
ECPLD3	Type QP, BL, QAF, QPF, QE, BQ	3P	1 Piece
ECPLD3R	Type QP, BL, QAF, QPF, QE, BQ (Red Color)	3P	1 Piece
ECQLD3	Type QP, BL, BQ, BQXD	1P	10 Pieces
ECQLD4	Type QT-Duplex	QT-Duplex Breakers	10 Pieces
ECQLN3②	150-225 MBKA, QN, QNR	n/a	1 Piece
ECQTH4	Type QP, BL, BQH	Designed for (3) 1P Breakers	1 Piece
Handle Tie			
Provide simultaneous swiching of 2 adjacent handles.			
ECQTH2	Type QT Duplex	Designed for (2) QT Duplex Breakers	25 Pieces
ECQTH3	Type QP, BL	2P	50 Pieces
Mechanical Interlock①			
ECQML12	Type QP, BL, BQ Interlock Bracket	Designed for 1" Breaker	10 Pieces
Handle Blocking Device			
For holding breaker in "ON" or "OFF" position. Not a lockout/tagout device			
ECQL1	Type QP, BL, BQ, BQXD	1P	10 Pieces
ECBX231M	Type QT-Duplex	1/2" Breakers	10 Pieces
Main Breaker Retainer			
ECMBR1③	EQ Load Centers		1 Piece
ECMBR2	Ultimate Load Centers		1 Piece
Mounting Accessories			
MB120	Type BQ, BQH Mounting Clips	1P	20 Pieces
FP9508	Type BQ, BQH FACE MOUNT PLATE	1P	10 Pieces
FP9555	Type BQ, BQH FACE MOUNT PLATE	2P	10 Pieces
FP9556	Type BQ, BQH FACE MOUNT PLATE	3P	10 Pieces
SMB6R	Type BQ MOUNTING BRACKET	1P, 2P, 3P	6 Pieces
TCH65K	Type BQ MOUNTING ADAPTER		500 Pieces
BR2	Type BQ, BQH, BQXD Back Mounting Plates	2P	10 Pieces
BR3	Type BQ, BQH, BQXD Back Mounting Plates	3P	10 Pieces
BR4	Type BQ, BQH, BQXD Back Mounting Plates	4P	10 Pieces
I0204ML1125	Type QP Back Mounting Plates	1P, 2P	10 Pieces
I0303ML3100	Type QP Back Mounting Plates	3P	10 Pieces
Replacement Lugs			
TA1Q1	Type BQ, NGG 100A Al Cu LGS	n/a	6 Pieces
TC1Q1	Type BQ, NGG 40A Al Cu LUGS	n/a	6 Pieces
Finger Shield			
BQFS1K	Type BQXD Finger Shield (Bulk Pack)	n/a	1000 Pieces
BQFS2	Type BQXD Finger Shield	n/a	2 Pieces
Filler Plate			
ECQF3	1" Filler Plate	n/a	5 Pieces

■ Built to order. Allow 2-3 weeks for delivery
 ① For a complete list of standby power mechanical interlock kits, see the Standby Generator Section XXXX
 ② For use with Ultimate Load Center Main Breakers

③ Not suitable for use on 15-50A, 10 AIC Type QP Circuit Breakers
 ④ QP Type includes QPH, HQP
 ⑤ BL Type includes BLH, HBL

⑥ BQ Type includes BQH, HBO
 ⑦ QAF Type includes QAFH, BAF, BAFH
 ⑧ QPF Type includes QPHF, BLF, BLHF
 ⑨ QE Type includes QEH, BLE, BLEH

Circuit Breakers

Accessories

White header

Padlocking Device

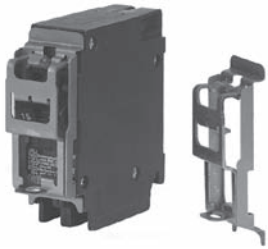

ECPLD1

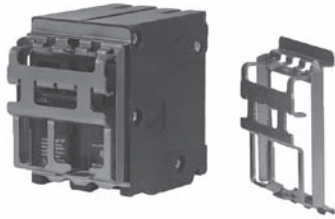

ECPLD2



ECQLD3



ECQLD4



ECQTH4

Handle Tie



ECQTH2



ECQTH3

Handle Blocking Device



ECQL1



ECBX231M

Main Breaker Retainer



ECMBR1



ECMBR2

Mechanical Interlock



ECQML12

Mounting Accessories

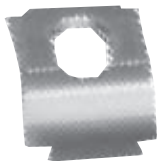

MB120

SMB6R

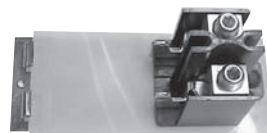

I0204ML1125

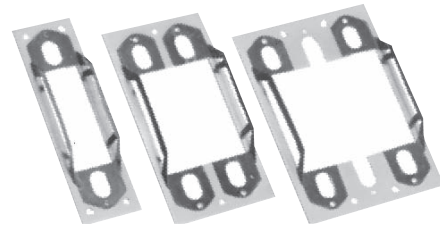

FP9508 FP9555 FP9556

Sentron Molded Case Circuit Breakers

External Accessories

Selection

Handle Ties with Padlock Device

Provide simultaneous switching of 2 or 3 adjacent handles.
Do not provide common trip.

For Use With Breaker Frame(s)	Catalog Number	Standard Package	Wt Lb/ Std Pkg
BQD, NGB, HGB, LGB	BQDHT2	10	½
	BQDHT3	10	½

Padlocking Devices

For locking breaker in "OFF" position.

Breaker Type	Catalog Number	Standard Package	Wt Lb/ Std Pkg
All QJ	HL9419	10	¼
All BQD, CQD, NGB, HGB, LGB	BQDPLD	1	⅙
NGG, HGG, LGG	HPLG	1	¼
EB, 1- thru 3-pole	HPLEB	1	⅙
EG, 3- and 4-pole only	HPLE	1	¼
All ED	ED2HPL	1	¼
All FD	FD6PL1	1	¼
All JD, LD, LMD	JD6HPL	1	¼
All MD, ND, PD, RD	MN6PLD	1	¼

Handle Blocking Devices

For holding breaker in "ON" or "OFF" position.
Not a lockout/tagout device.

Breaker Type	Catalog Number	Standard Package	Wt Lb/ Std Pkg
All QJ	QJHS1 ^①	25	1
All BQD, CQD, GG, GB	BQDHBD	1	¼
EG	HBDE	1	¼
All ED	E2HBL	1	¼
All FD	FD6HB1	1	½
All JD, LD, LMD	JD6HBL	1	½
All MD, ND, PD, RD	MN6BL	1	½

Handle Extensions

For replacement. One extension shipped with breaker.

Breaker Type	Catalog Number	Standard Package	Wt Lb/ Std Pkg
All MD, ND, PD, RD	EX11	1	2

Terminal Shields

Breaker Type	Poles	Catalog Number	Standard Package
NGG, HGG, LGG	3	TSSG3A	1



FD Padlocking Device
FD6PL1



FD Handle Blocking Device
FD6HB1

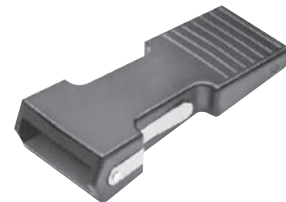

Handle Extension
EX11

■ Built to order. Allow 2-3 weeks for delivery.

① Sold only in standard package quantities.

Sentron Molded Case Circuit Breakers

External Accessories

Selection

Face Mounting Plates

For Use With Breaker Frame(s)	Number of Poles	Catalog Number	Standard Package	Wt Lb/Std Pkg
CQD, CQD6	1	CQDFMB1	1	¼
	2	CQDFMB2■	1	¼
	3	CQDFMB3■	1	¼
NGG, HGG, LGG	1	FMPG1	1	¼
	2	FMPG2	1	¼
	3	FMPG3	1	¼

Back Mounting Plates

ED2, ED4, ED6, HED4, HED6	1	E2BMB	1	¼
---------------------------	---	-------	---	---

Mounting Screw Kits

CQD, CQD6	CQDSMK ^①	1	1¼
NGG, HGG, LGG	MSKG4 ^①	1	¼
All QJ	MSQJ ^①	1	1
All ED (CED6 requires 2 kits)	MSE6 ^②	1	¼
	MSE6100 ^②	100 ^③	1
All FD (CFD6 requires 2 kits)	MSF6 ^②	1	¼
	MSF650 ^③	50 ^③	1
All EG 1-pole	MSKE1	—	—
All EG 2-pole	MSKE2	—	—
All EG 3 or 4-pole	MSKE4	—	—
All JD, LD	MSJ6 ^②	1	¼
All LMD	MSLMD	1	¼
All MD, ND,	MSMN	1	¼
All PD, RD	MSPR6	1	2

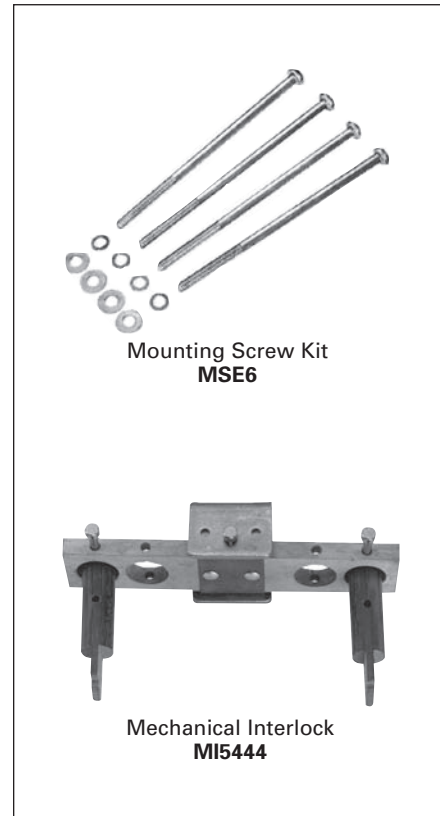

“MI” Mechanical Interlocks

For Use With Breaker Type(s)	Panel ^⑦ Mounted	Plug-in Mounted	Standard Package	Wt Lb Std Pkg
All EG (Sliding Bar)	HSBE	—	1	—
All QJ	CSO	—	Complete with two breakers	1
All FD	MI5444	MI5444	1	—
All JD, LD	MI5413 ^④	—	1	1
All LMD	MI5406 ^④ ■	—	1	1
All MD	MI5404 ^④ ■	—	1	3
All ND	MI5404 ^④ ■	—	1	3
All PD, RD	MI5405 ^④ ▲	—	—	—

■ Built to order. Allow 2–3 weeks for delivery.

▲ Built to order. Allow 6–8 weeks for delivery.

① Kit consists of 4 screws and washers.

② Consists of 1 screw and washers (order 100).

③ Consists of 1 screw and washers (order 50).

④ With mechanical interlock in place, no accessory can be installed into circuit breaker right pole.

⑤ Addition of the mechanical interlock will prevent accessory installation in the left pole.

⑥ Sold only in standard package quantities. Multiply List Price Each times package quantity for full price.

⑦ Mechanical interlock is not designed for use within Siemens panelboards.

Sentron Molded Case Circuit Breakers

External Accessories

• Revised •
07/20/14

Selection

Rotary Door Mounted Operating Handles Types 1, 3, 3R, 12, 4 4X

For Use With Breaker Frames	Complete Mechanism		Handle Only	Breaker Operator	Shaft Only	
	Catalog Number		Catalog Number	Catalog Number	Length (inches)	Catalog Number
	Standard Depth	Variable Depth				
EG	RHVE64X	RHVE124X	—	—	—	—
ED ^①	CRHOESD	CRHOEVD	CRHOH ^③	RHOEBO	2	RHOSSD
FD	CRHOFSD	CRHOFVD		RHOFBO	12	RHOSVD
JD, LD	CRHOJSD	CRHOJVD		RHOJBO	16	RHOSXD
LMD	CRHOLMSD	CRHOLMVD		RHOLMBO		
MD, ND PD, RD	RHONSD	RHONVD	RHOH ^③	RHONBO ^④	3 12 24	RHONSSD▲ RHONSVD RHONSXD

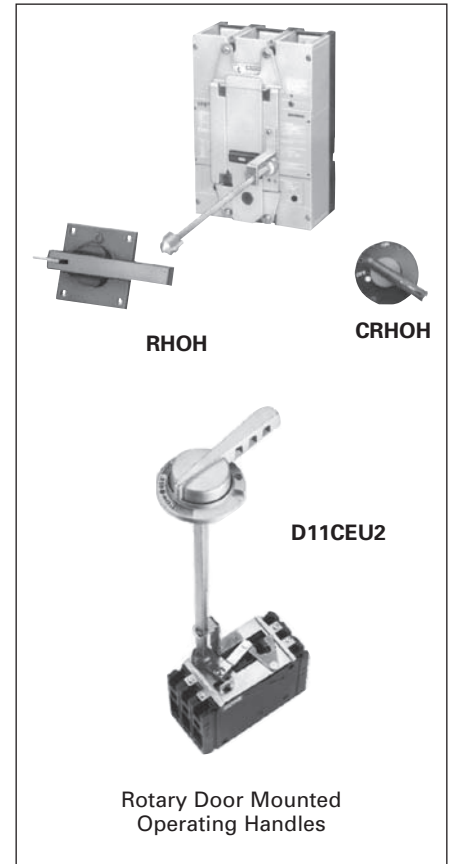

Rotary Door Mounted Operating Handles Types 1 & 12

For Use With Breaker Frames	Standard Depth Catalog Number	Variable Depth Catalog Number	Handle and Shaft Catalog Number	Breaker Operator Catalog Number
CQD, NGG, HGG, LGG	—	RHOCQVD	RHOH62	CQDOP
ED	D11CEU1	D11CEU2	—	—
FD	D11CFU1▲	D11CFU2	—	—
JD, LD	—	D11CJU2	—	—

For CQD, NGG, HGG and LGG red emergency handle, order assembly **RHOCQVDE** (includes handle and operator) ▲
For CQD, NGG, HGG and LGG in a NEMA 3R enclosure, order **CQDOP34** operator, **RHOH** handle and **RHOSVD** shaft.
For CQD, NGG, HGG and LGG in a NEMA 4 or 4X enclosure, order **CQDOP34** operator, **RHOH4** handle and **RHOSVD** shaft.

Through Door Mounted Operating Handles^② Types 1 & 12

For Use With Breaker Frames	Standard Depth	Variable Depth
	Catalog Number	Catalog Number
CQD, NGG, HGG, LGG	FMHOS	—
QJ	OH9498■	VH9499
EG (3 & 4-Pole only)	RHFESD	—
EG (red handle)	RHFESDEM	—
ED	E2RH1	E2RHV9
FD	F6RH1	F6RHV9

Door Latch Kits

Type	Catalog Number	Catalog Number
	Right Hand	Left Hand
2 point latch	DKR2	DKL2■
3 point latch	DKR3	DKL3■

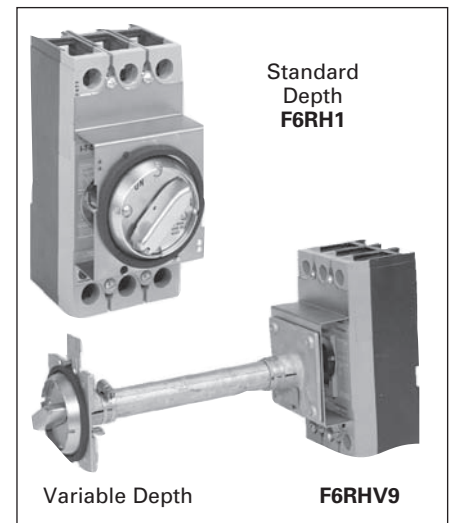
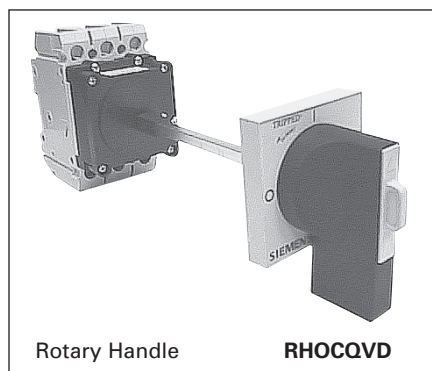

- Built to order. Allow 2-3 weeks for delivery.
- ▲ Built to order. Allow 6-8 weeks for delivery.
- ① For use on 3-pole ED frame only.

- ② Meets the requirements of NFPA 79, section 5.3.3.1 for locking external operator disconnecting devices.
- ③ For 3 or 3R, order shaft and breaker operator as shown, and handle RHOH. For 4 & 4X, order handle RHOH4. Consult sales office for additional EG operator shaft lengths.

- ④ For extended shaft support order catalog number RHONSB2.

Sentron Molded Case Circuit Breakers

External Accessories

Selection

Max-Flex™, Flange Mounted Variable Depth Operators^③

Frames	NEMA Type	Complete Kit Catalog Number	Handle Only Catalog Number	Breaker Operator Catalog Number	36" Cable Catalog Number
NGG	1, 3 (R), 12	MFKG3R3	MFHM3R	MFMG	MFCF036
	4 (x)	MFKG4X3	MFHM4X		
EG	1, 3 (R), 12	MFKE3 ^④	—	—	—
	4 (x)	MFKE4X3	—		
ED	1, 3 (R), 12	FHOE036 ^①	FHOH	FHOEBO ^①	FHOEC036
	4 (x)	—	FHOH4		
FD	1, 3 (R), 12	FHOF036	FHOH	FHOFBO	FHOF036
	4 (x)	—	FHOH4		
JD, LD, SJD, SLD	1, 3 (R), 12	FHOJ036	FHOH	FHOJBO	FHOJC036
	4 (x)	—	FHOH4		
LMD	1, 3 (R), 12	FHOLM036	FHOH	FHOLMBO	FHOJC036
	4 (x)	—	FHOH4		
MD, ND, PD, RD, SMD, SND, SPD	1, 3 (R), 12	FHON048	FHOHN	FHONBO	FHONC048 ^②
	4 (x)	—	FHOHN4		

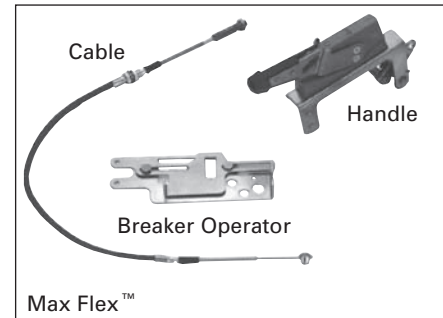

Max-Flex™ handles are available with solid black handles instead of the customary "red for on" flange handle. These are preferred for use in IEC markets, where red handles have specific meaning. Order components separately, appending the letter "i" to the catalog number (e.g. FHOHI).

Alternate Length Cable Only

	ED	FD	JD/LD/LMD	MD/ND/PD/RD
Inches	Catalog Number	Catalog Number	Catalog Number	Catalog Number
48	FHOEC048	FHOF048	FHOJC048	FHONC048
60	FHOEC060	FHOF060	FHOJC060	FHONC060
72	FHOEC072	FHOF072	FHOJC072	FHONC072
84	FHOEC084▲	FHOF084▲	FHOJC084▲	FHONC084▲
96	FHOEC096	FHOF096	FHOJC096	FHONC096
120	FHOEC120▲	FHOF120	FHOJC120▲	FHONC120▲
144	FHOEC144▲	FHOF144▲	FHOJC144▲	FHONC144▲

Handle Auxiliary Switch

For use with Max-Flex and Rotary Door operators (FHOH and RHOH). 1 NO and 1 NC contact (Form C).

For Use With	Catalog Number
ED, FD, JD, LD, LMD, ND, PD, RD, SD, Max Flex	HAS1

Fixed Depth Flange Mounting

Frames	Minimum Enclosure Depth	NEMA Type	Left Hand Mount	Right Hand Mount
			Catalog Number	Catalog Number
ED ^⑤	6.44	1, 3R, 12	DFBEL▲	DFBER▲
			4, 4X	DFBEL4▲
FD	6.44	1, 3R, 12	DFBFL▲	DFBFR▲
			4, 4X	DFBFL4▲

Max-Flex™ handles are available with solid black handles instead of the customary "Red for On" flange handle. These are preferred for use in IEC markets, where red handles have specific meaning. Order components separately, appending the letter "i" to the catalog number (e.g. FHOHI).

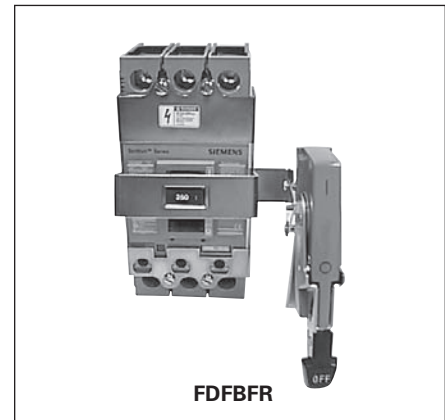

▲ Built to order. Allow 6–8 weeks for delivery.

① For 1- or 2-pole breaker order FHOED036 complete kit or FHOEDBO breaker operator only. Use MFHM3R handle.

② 48 inch cable is standard length for M through R frame Max-Flex operators.

③ Meets requirements of NFPA 79, section 5.3.3.1 for locking external operator disconnecting devices

④ Consult sales office for additional cable lengths for EG Flex Shaft Operators. For 3-Pole only.

⑤ 3-Pole ED only.

Sentron Molded Case Circuit Breakers

External Accessories

Selection/Dimensions

Telemand® Motor Operator

Breaker Frame	AC Voltage	Hinged to Open Down Catalog Number
ED except CED	120	MOE6120
	240	MOE6240▲

ED motor operator opens downward.

Breaker Frame	DC Voltage	Hinged to Open Right Catalog Number	AC Voltage	Hinged to Open Right Catalog Number
FD	24	MOF6024DC▲	120	MOF6120
	48	MOF6048DC▲	240	MOF6240
	125	MOF6125DC▲		
JD, LD	24	MOJ6024DC▲	120	MOJ6120
	48	MOJ6048DC▲	240	MOJ6240
	125	MOJ6125DC▲		
LMD	24	MOLMD6024DC▲	120	MOLMD6120
	48	MOLMD6048DC▲	240	MOLMD6240
	125	MOLMD6125DC▲		
MD, ND, PD, RD	—	—	120	MOMN6120
	—	—	240	MOMN6240

To order FD through RD motor operators with Left side hinges, add "L" to catalog number (e.g. MOF6120L). List prices are the same.▲

Dimensions

Frame	A	B	C	D	E	F
ED	7.04	4.31	—	4.31	13.84	8.84
FD	9.50	4.55	1.60	6.84	9.70	7.58
JD, LD, LMD	11.00	7.50	0.79	8.34	9.85	7.74
MD, ND, PD, RD	16.00	9.00	—	9.83	13.13	10.13

Operating Currents

Catalog Number	On			Off			Reset (Amps)
	In-Rush (Amps)	Running (Amps)	Time (msec)	In-Rush (Amps)	Running (Amps)	Time (msec)	
MOE6120	10.25	2.3	550	10	2.3	400	2.3
MOE6240	5.2	1.1	500	5	1	330	1.1
MOF6120/L	13.6	5.5	200	13.6	5.5	175	5.5
MOF6240/L	7.6	3.5	200	7.6	3.5	185	3.5
MOLMD6120/L	13.6	6	210	13.6	6	185	6
MOJ6120/L	13.6	6	210	13.6	6	185	6
MOJ6240/L	7.6	3.5	217	7.6	3.5	185	3.5
MOMN6120/L	30.2	13.2	240	30.2	13.2	210	13.2
MOMN6240/L	14.7	6	260	14.7	6	230	6



Telemand Motor Operator

FD, JD, LD, LMD, MD, ND, PD, RD Frames

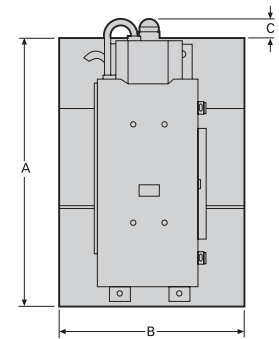

Front View

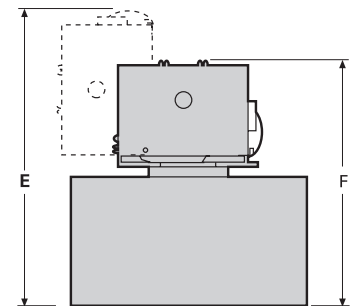

Bottom View

For inches / millimeters conversion, see Application Data section.

▲ Built to order. Allow 6-8 weeks for delivery.

Plug-In Mounting Assemblies, Including Base and Tulip Assemblies

For Use With Breaker Frames	Poles	Line Side	Load Side	Steel Switchboard Mounting Plate ^① Catalog Number
		Catalog Number ^②	Catalog Number ^②	
EG	3	PCBERC3 ^③	—	—
	4	PCBERC4 ^③	—	
All ED except CED	2	PC2637▲	PC2638▲	PL2616
	3	PC2657	PC2658	
CED	2	PC2637▲	PC2638▲	PL2617
	3	PC2657	PC2658	
All FD except CFD	2	PC4753▲	PC4753▲	PL4762
	3	PC4754	PC4754	
CFD	2	PC4753▲	PC4753▲	PL4763
	3	PC4754	PC4754	
All JD except CJD	2	PC5777▲	PC5777▲	PL5796
	3	PC5778	PC5778	
Kit CJD, SCJD	3	PCCJD	PCCJD	PL5797
All LD except CLD	2	PC5660▲	PC5660▲	PL5680
	3	PC5661	PC5661	
Kit CLD, SCLD	3	PCCLD	PCCLD	PL5797
All MD	2	PC5662▲	PC5662▲	PL9698
	3	PC5663	PC5663	
All ND	2	PC5664 ^③ ▲	PC5664 ^③ ▲	PL9699
	3	PC5666 ^③	PC5666 ^③	

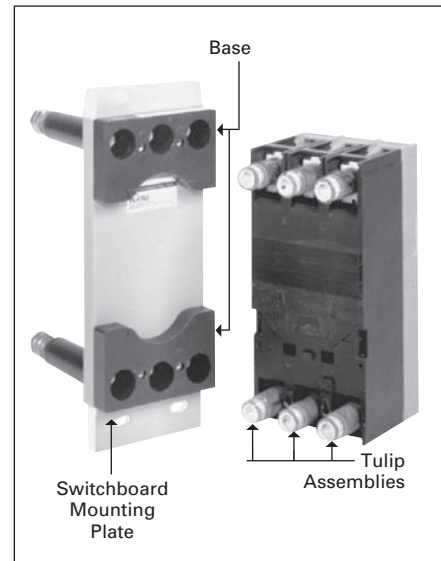

Tulip Assemblies Separately

For Frame	2-Pole	3-Pole
	Catalog Number	Catalog Number
ED	TCE2▲	TCE3▲
FD	TCF2▲	TCF3▲
JD	TCJ2▲	TCJ3▲
LD	TCL2▲	TCL3▲
MD	TCM2▲	TCM3▲
ND	TCN2▲	TCN3▲

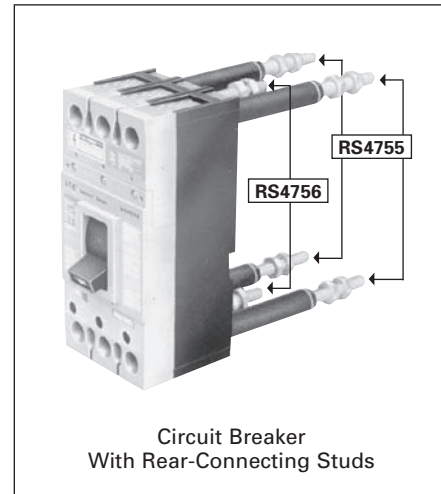

Rear-Connecting Studs

For Use With Breaker Frames	Ampere Rating	Description	Extension Behind Breaker (inches)	Line Side	Load Side
				Catalog Number ^④	Catalog Number ^④
All ED	100	Line Side (Short)	2.38	RS2643 ^⑤ ▲	—
	100	Load Side (Short)	2.38	—	RS2644 ^⑤ ▲
	100	Line Side (Long)	4.88	RS2641 ^⑤ ▲	—
	100	Load Side (Long)	4.88	—	RS2642 ^⑤ ▲
All FD	250	Short	3.12	RS4756 ^⑤ ▲	RS4756 ^⑤ ▲
	250	Long	7.06	RS4755 ^⑤ ▲	RS4755 ^⑤ ▲
All JD	400	Short	5.85	RS5774▲	RS5774▲
	400	Long	11.20	RS5773▲	RS5773▲
All LD	600	Short	5.85	RS5784▲	RS5784▲
	600	Long	11.20	RS5783▲	RS5783▲
CJD, SCJD CLD, SCLD	Add required shield kit.				CLRSJL3
LM(X)D6, HLM(X)D6	800	Short	5.85	RS5788▲	RS5788▲
		Long	11.20	RS5787▲	RS5787▲
All MD, ND	1200	Short	5.50	RS5786▲	RS5786▲
		Long	8.00	RS5785▲	RS5785▲

▲ Built to order. Allow 6–8 weeks for delivery.

①Furnished at no extra charge when ordered with plug-in mounting assembly.

②Each piece catalog number consists of (1) mounting block assembly and required tulip assemblies (2) for 2-pole, (3) for 3-pole

③For vertical bus mounting — for horizontal, substitute PC5665 for PC5664 and PC5667 for PC5666.

④Price includes one current stud, insulating tube, stud nuts and terminal shields, when required.

⑤For proper electrical clearance, studs must alternate between short and long stud lengths on circuit breaker poles (e.g. SLSSL or LSLSL).

⑥Plug-in assembly for EG breakers include line and load side in one assembly.

Molded Case Circuit Breakers

Unusual Operating Conditions

Reference

Note: The information provided on this and the next page is intended for reference and recommendation only. Because several variables can act on a circuit breaker's performance at the same time, the data below is based less on controlled testing, than on experience and engineering judgment. Contact Siemens for further information on special conditions and treatment.

High Ambient Temperatures

Because thermal-magnetic trip breakers are temperature sensitive and calibrated for a specific ambient of 40°C (104°F) (average enclosure temperature), a higher ambient will cause the breaker to trip at lower current than its nameplate rating, in other words, causing the breaker to "derate" (see Table 1). Similarly, the current carrying capacity of a circuit conductor is based upon a certain ambient temperature, a higher ambient will reduce its current carrying capacity, causing it to "derate." Thus, with a fluctuating temperature, a thermal-magnetic breaker will derate nearly parallel with its connected circuit conductors and maintain close circuit protection. If the application temperature exceeds 40°C (104°F) and is known, either a breaker specially calibrated for the higher ambient or one oversized according to Table 1 may be selected. In a case such as this, the circuit conductors should be oversized as well. Siemens Sensitrip® III and Type SB Encased Systems Breakers are insensitive to temperature changes. However, they do include circuitry to protect the components from abnormally high temperatures.

Moisture — Corrosion

For atmospheres having high moisture content and / or where fungus growth is prevalent, a special preventive treatment may be required.

Where the air is heavily laden with corrosive elements, breakers made with special corrosion-resistant finishes may be required.

Altitude

Reduced air density at altitudes greater than 6600 ft. (2000 meters) affects the ability of a molded case circuit breaker to transfer heat and interrupt faults. Therefore, circuit breakers applied at these altitudes should have interrupting, insulation and continuous currents derated as indicated in Figure 1.

Table 1 — Temperature Derating Data for Thermal-Magnetic Breakers

Reference Ampere Rating at 40° C (104° F)	Ampere Rating at:			Siemens Breaker Frames	
	25° C (77° F)	50° C (122° F)	60° C (140° F)		
15	17	13	11	BQ, BL, BQD, CQD, GG, GB, ED	
20	22	18	16		
25	28	23	21		
30	33	28	26		
35	39	30	25		
40	44	37	34		
50	55	46	42		
60	66	56	52		
70	77	65	60		
90	99	84	78		
100	110	94	87		
125	137	114	100		QJ FD JD LD MD ND PD RD
150	165	136	120		
175	192	159	140		
200	220	182	160		
225	247	205	180		
250	275	235	220		
300	330	276	252		
350	385	325	301		
400	440	372	340		
500	550	468	435		
600	660	564	525		
700	770	658	613		
800	880	754	704		
900	990	828	749		
1000	1100	900	825		
1200	1320	1090	1000		
1400	1540	1304	1148		
1600	1760	1500	1320		
1800	1980	1690	1485		
2000	2200	1880	1650		

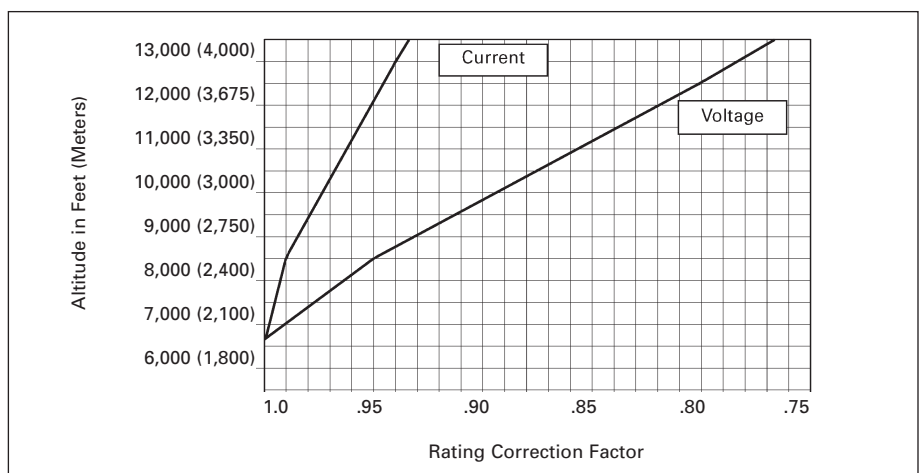

Figure 1 — Altitude Adjustment

400 Hz Systems^①

Siemens molded case circuit breakers can be applied for overcurrent protection on 400Hz systems, commonly used to power computer installations, aircraft, military and other specialty equipment. Below are basic guidelines.

Circuit Breaker Derating Required

This table lists the maximum continuous current carrying capacity for Siemens breakers at 400Hz. Due to the increased resistance of the copper sections resulting from the skin effect produced by eddy currents at these frequencies, circuit breakers in many cases require derating. The thermal derating on these devices is based upon 100%, three phase application in open air in a maximum of 40°C (104°F) with 48 in. (1219 mm) of the specified cable or bus at the line and load side. Additional derating of not less than 20% will be required if the circuit breaker is to be utilized in an enclosure. Further derating may be required if the enclosure

ambient temperature exceeds 40°C (104°F).

Cable and Bus Sizing

The cable and bus sizes to be utilized at 400Hz are not based on standard National Electric Codes tables for 60Hz application. Larger cross sections are necessary at 400Hz. All bus bars specified are based upon mounting the bars in the vertical plane to allow maximum air flow. All bus bars are spaced at a minimum of 0.25 in. (6 mm) apart. Mounting of bus bars in the horizontal plane will necessitate additional drafting. Edgewise orientation of the bus may change the maximum ratings indicated. If additional information is required for other connections of cable or bus, contact Siemens for information.

Application Recommendations

It is recommended that temperatures be measured on the line and load terminals or T-connectors of the center pole. These

are usually the hottest terminals with a balanced load. A maximum temperature of 75°C (35°C over a maximum ambient of 40°C) would verify the particular application. Temperature profiles taken on these breakers can be correlated to ensure that the hottest points within the breaker are within the required temperature limits.

Factory Configuration

When required, molded case circuit breakers may be factory calibrated for 400Hz application. These breakers are specially labeled for 400Hz usage and their nameplate current rating will include the necessary derating factory. The highest "Maximum Continuous Amperes" rating at 400Hz, found in the table below approximates the highest specially calibrated 400Hz nameplate ampere rating available for a given frame size. Contact Siemens for ordering information on other breakers applied in 400Hz systems.

400Hz Breakers

Siemens Breaker Type	Maximum Continuous Ampere Rating At 40°C (104°F) ^②			75°C (167°F) Copper Cable per Pole	
	60HZ		Enclosed After Derating	No of Pieces	Wire Size
	Open Air	Open Air ^③			
ED2, ED4, ED6, BOD, HED4, HED6, CED6	15	15	12	1	#14
	20	20	16	1	#12
	25	25	20	1	#10
	30	30	24	1	#10
	35	35	28	1	#10
	40	40	32	1	#8
	45	43	34	1	#8
	50	48	38	1	#8
	60	57	46	1	#6
	70	67	54	1	#4
	80	76	61	1	#4
	90	86	69	1	#3
	100	95	76	1	#3
	110	105	84	1	#2
125	119	95	1	#1	
QJ2, QJH2, QJ2H, HQJ2, HQJ2H, FD6, FXF6, HFD6, HFXD6, CFD6	70	63	50	1	#4
	80	72	58	1	#4
	90	80	64	1	#3
	100	90	72	1	#3
	110	95	75	1	#2
	125	105	84	1	#1
	150	125	100	1	#1/0
	175	140	112	1	#2/0
	200	160	128	1	#3/0
	225	180	144	1	#4/0
	250	200	160	1	250 kcmil
JXD2, JD6, JXD6, HJD6, HJXD6, HHJD6, HHJXD6, CJD6	200	170	136	1	#3/0
	225	190	152	1	#4/0
	250	210	168	1	250 kcmil
	300	240	192	1	350 kcmil
	350	260	208	1	500 kcmil
JD6, JXD6, HJD6, HJXD6 100% Rated	400	300	240	2	#3/0
	200	170	170	2	#3/0
	225	190	190	2	#4/0
	250	210	210	1	250 kcmil
	300	240	240	1	350 kcmil
	350	260	260	1	500 kcmil
	400	300	300	2	#3/0

Siemens Breaker Type	Maximum Continuous Ampere Rating At 40°C (104°F) ^②			75°C (167°F) Copper Cable per Pole	
	60HZ		Enclosed After Derating	No of Pieces	Wire Size
	Open Air	Open Air ^③			
LD6, LXD6, HLD6, HLXD6, HHLXD6, HHLXD6, CLD6	250	210	168	1	250 kcmil
	300	240	192	1	350 kcmil
	350	260	208	1	500 kcmil
	400	300	240	2	#3/0
	450	340	272	2	#4/0
	500	375	300	2	250 kcmil
	600	420	336	2	350 kcmil
	250	210	210	1	250 kcmil
	300	240	240	1	350 kcmil
	350	260	260	1	500 kcmil
LD6, LXD6, HLD6, HLXD6, 100% Rated	400	300	300	2	#3/0
	450	340	340	2	#4/0
	500	375	375	2	250 kcmil
	600	420	420	2	350 kcmil
	500	400	320	2	250 kcmil
	600	430	360	2	350 kcmil
	700	500	400	3	250 kcmil
MD6, MXD6, HMD6, HMXD6, CMD6	800	560	448	3	300 kcmil
	500	400	400	2	250 kcmil
	600	430	430	2	350 kcmil
	700	500	500	3	250 kcmil
MD6, MXD6, HMD6, HMXD6, CMD6 100% Rated	800	560	560	3	300 kcmil
	800	560	448	3	300 kcmil
	900	600	480	3	350 kcmil
	1000	650	520	3	400 kcmil
ND6, NXD6 HND6, HNXD6, CND6	1200	780	624	4	350 kcmil
	900	600	600	3	350 kcmil
	1000	650	650	3	400 kcmil
	1200	780	780	4	350 kcmil
PD6, PXD6, HPD6, HPD6, CPD6, 100% Rated	1200	780	624	4	400 kcmil
	1400	850	680	4	500 kcmil
	1600	960	768	5	500 kcmil
	1200	780	780	4	400 kcmil
RD6, RXD6, HRD6, HRXD6 80% Rated	1400	850	850	4	500 kcmil
	1600	960	960	5	500 kcmil
	1600	960	768	5	500 kcmil
	1800	1080	864	5	500 kcmil
	2000	1200	960	6	500 kcmil

①The information provided on this page is intended for reference and recommendation only. Because several variables can act on a circuit breaker's performance at the same time, the data above is based less on

controlled testing, than on experience and engineering judgment. Contact Siemens for further information on special conditions and treatment.

②Additional derating may be required if the ambient

temperature is greater than 40°C (104°F).

③Calculated after derating to compensate for the heating of the copper conductor, caused by the skin effect generated by eddy currents produced at 400/415Hz.

Molded Case Circuit Breakers

Unusual Operating Conditions

Reference

Unusual Operating Conditions 400 Hz Systems

Circuit Breaker Derating Required

This table lists the maximum continuous current carrying capacity for Siemens breakers at 400Hz. Due to the increased resistance of the copper sections resulting from the skin effect produced by eddy currents at these frequencies, circuit breakers in many cases require derating. The thermal derating on these devices is based upon 100%, three phase application in open air in a maximum of 40°C (104° F) with 48 in. (1219 mm) of the specified cable or bus at the line and load side. Additional derating of not less than 20% will be required if the circuit breaker is to be utilized in an enclosure. Further derating may be required if the enclosure ambient temperature exceeds 40°C(104° F).

Cable and Bus Sizing

The cable and bus sizes to be utilized at 400Hz are not based on standard National Electric Codes tables for 60Hz application. Larger cross sections are necessary at 400Hz. All bus bars specified are based upon mounting the bars in the vertical plane to allow maximum air flow. All bus bars are spaced at a minimum of 0.25 in. (6 mm) apart. Mounting of bus bars in the horizontal plane will necessitate additional drafting. Edgewise orientation of the bus may change the maximum ratings indicated. If additional information is required for other connections of cable or bus, contact Siemens for information.

Application Recommendations

It is recommended that temperatures be measured on the line and load terminals or T-connectors of the center pole. These are usually the hottest terminals with a balanced load. A maximum temperature of 75°C (35°C over a maximum ambient of 40°C) would verify the particular application. Temperature profiles taken on these breakers can be correlated to ensure that the hottest points within the breaker are within the required temperature limits.

Interrupting Rating

Circuit breakers used in 400 Hz systems are limited to a 5000 A interrupting rating. If higher ratings are required, consult Siemens.

Breaker type	Maximum continuous ampere rating at 40°C (104°F)②			75°C (167F) Copper cable per pole	
	60HZ		400HZ	No of pieces	Wire size
	Open air	Open air③	Enclosed after derating		
DG	50	48	38	1	#8
	60	57	46	1	#6
	70	63	50	1	#4
	80	72	58	1	#4
	90	80	64	1	#3
	100	90	72	1	#3
	110	95	75	1	#2
	125	105	84	1	#1
FG	150	125	100	1	#1/0
	100	90	72	1	#3
	110	95	75	1	#2
	125	105	84	1	#1
	150	125	100	1	#1/0
	175	140	112	1	#2/0
	200	160	128	1	#3/0
	225	180	144	1	#4/0
JG	250	200	160	1	250 kcmil
	250	210	168	1	250 kcmil
	300	240	192	1	350 kcmil
	350	260	208	1	500 kcmil
JG 100% Rated	400	300	240	2	#2/0
	250	210	210	1	250 kcmil
	300	240	240	1	350 kcmil
	350	260	260	1	500 kcmil
LG	400	300	240	2	#3/0
	500	375	300	2	250 kcmil
	600	420	336	2	350 kcmil

Breaker type	Maximum continuous ampere rating at 40°C (104°F)②			75°C (167F) Copper cable per pole	
	60HZ		400HZ	No of pieces	Wire size
	Open air	Open air③	Enclosed after derating		
LG	400	300	240	2	#3/0
	500	375	300	2	250 kcmil
	600	420	336	2	350 kcmil
MG	600	430	360	2	350 kcmil
	700	500	400	3	250 kcmil
	800	560	448	3	300 kcmil
MG 100% Rated	600	430	430	2	350 kcmil
	700	500	500	3	250 kcmil
	800	560	560	3	300 kcmil
NG	800	560	448	3	300 kcmil
	900	600	480	3	350 kcmil
	1000	650	520	3	400 kcmil
	1200	780	624	4	350 kcmil
NG 100% Rated	900	600	600	3	350 kcmil
	1000	650	650	3	400 kcmil
	1200	780	780	4	350 kcmil
	1200	780	624	4	400 kcmil
PG	1400	850	680	4	500 kcmil
	1600	960	768	5	500 kcmil
	1200	780	780	4	400 kcmil
PG 100% Rated	1400	850	850	4	500 kcmil
	1600	960	960	5	500 kcmil

① The information provided on this page is intended for reference and recommendation only. Because several variables can act on a circuit breaker's performance at the same time, the data above is based less on controlled testing, than on experience and engineering

judgment. Contact Siemens for further information on special conditions and treatment.

② Additional derating may be required if the ambient temperature is greater than 40°C (104°F).

③ Calculated after derating to compensate for the heating of the copper conductor, caused by the skin effect generated by eddy currents produced at 400/415HZ.